

# Neutrino Interaction Physics

## Lecture 1: Introduction of neutrino interactions

1. Overview
2. Neutrino lepton scattering
3. Neutrino quark scattering (DIS)
4. Neutrino nucleus reactions

## Lecture 2: Neutrino interactions for long baseline oscillation experiments

1. Overview
2. CCQE interaction
3. Baryonic resonances
4. Shallow inelastic scattering (SIS)

Teppei Katori  
King's College London  
Oct. 08, 2024

Subscribe “NuSTEC-News”  
[nustec.fnal.gov](http://nustec.fnal.gov)  
like “NuSTEC-News” on Facebook page  
use hashtag #nuxsec

# 1. From eV to EeV: Neutrino cross sections across energy scales

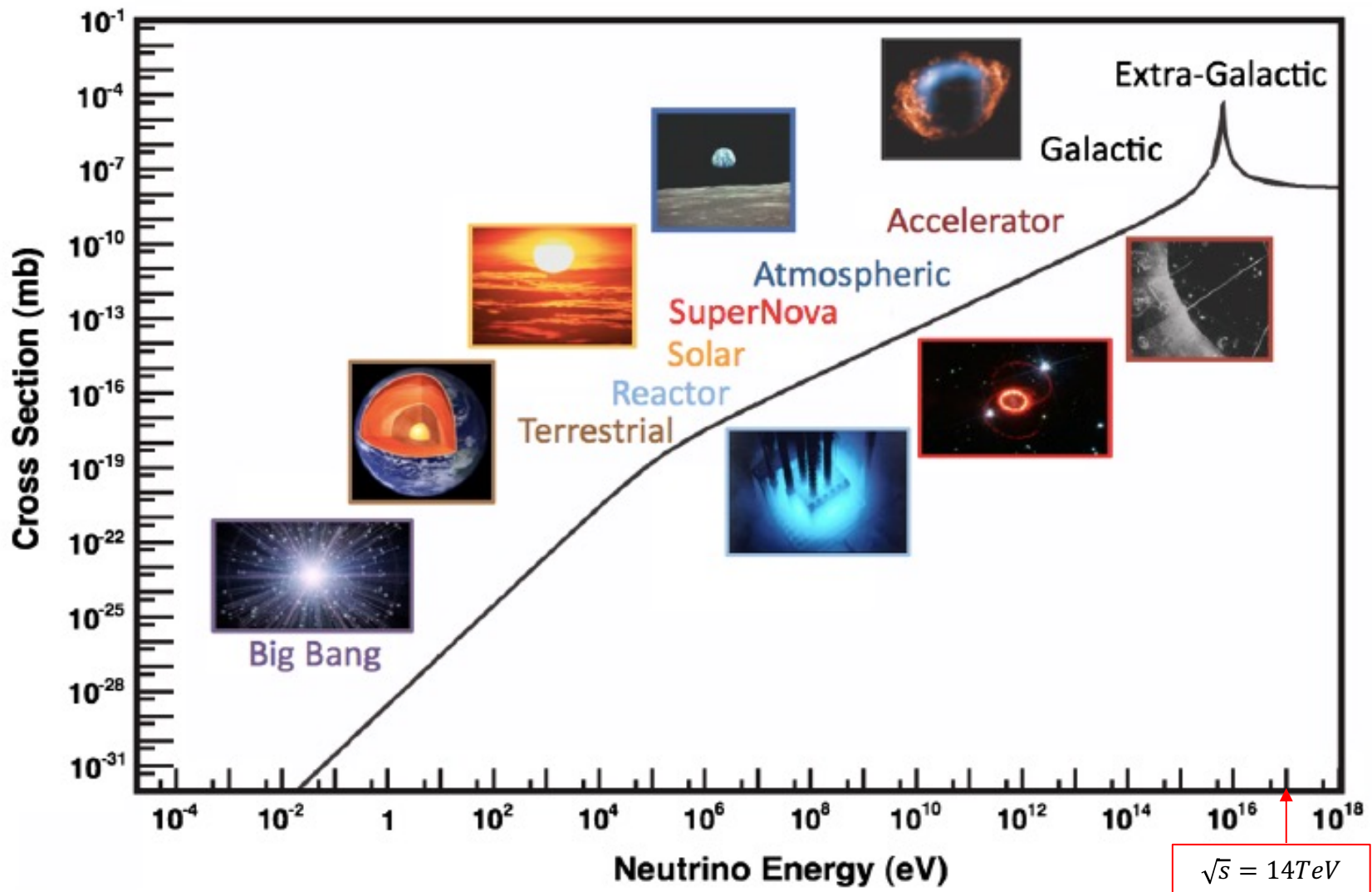

# 1. From eV to EeV: Neutrino cross sections across energy scales

lecture 1: Everything not relevant with long-baseline neutrino oscillation experiments  
lecture 2: nuxsec for long-baseline neutrino oscillation experiments (DUNE, HyperK)

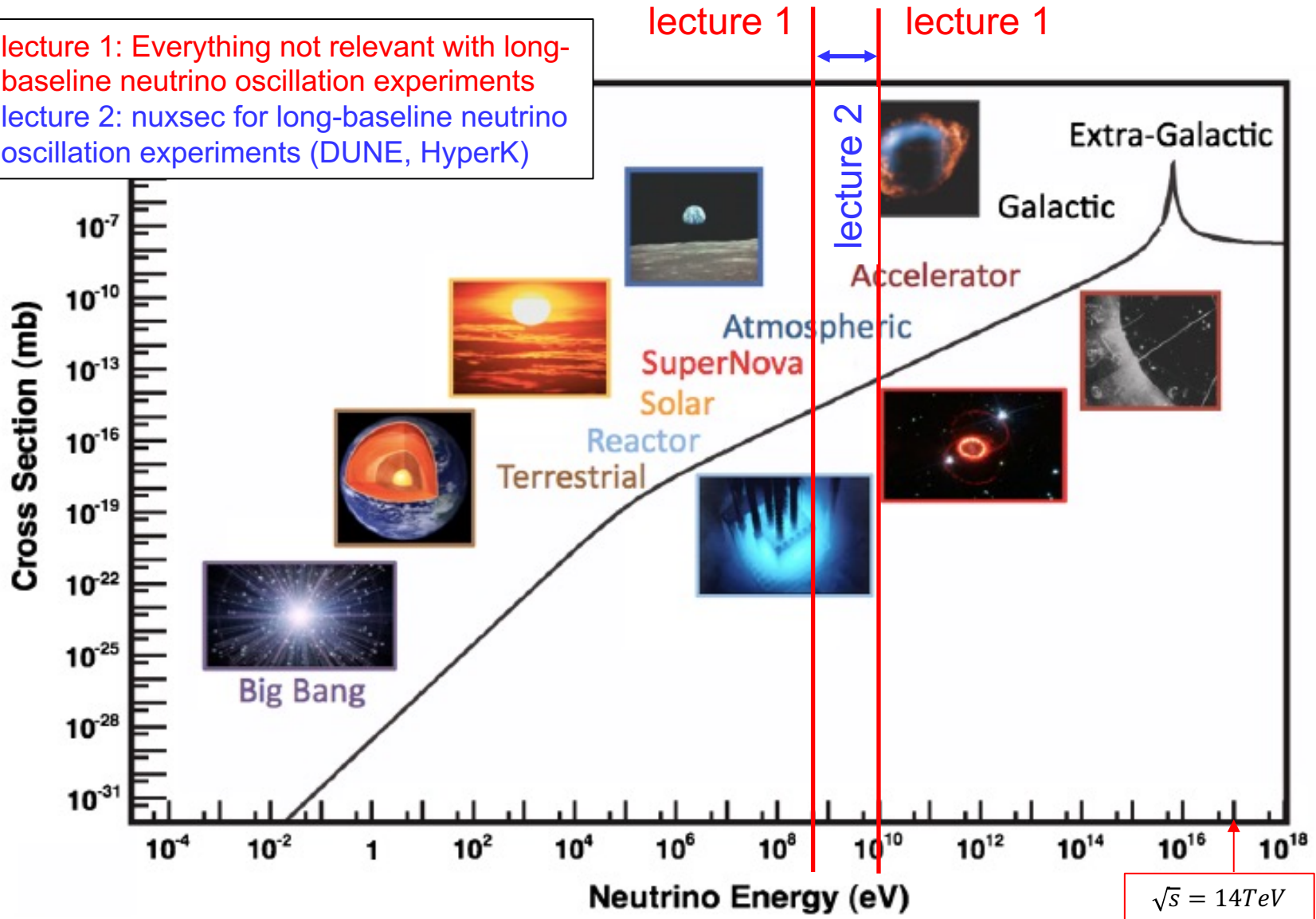

# 1. Scattering measurements

Size of wave packet  $\sim$  momentum transfer ( $\sim$ energy)

$$\hbar c = 197 \text{ MeV} \cdot \text{fm} \rightarrow 200 \text{ MeV} \sim 1 \text{ fm (size of nucleon)}$$

$\sim 1$  GeV neutrino beam  
(T2K, NOvA, HyperK, DUNE)

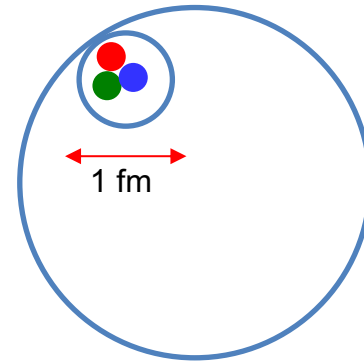
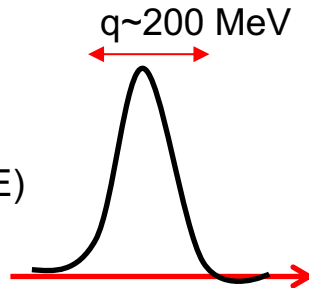

# 1. Scattering measurements

Size of wave packet  $\sim$  momentum transfer ( $\sim$ energy)

$$\hbar c = 197 \text{ MeV} \cdot \text{fm} \rightarrow 200 \text{ MeV} \sim 1 \text{ fm (size of nucleon)}$$

$\ll 1$  GeV neutrino beam  
(solar neutrinos, etc)

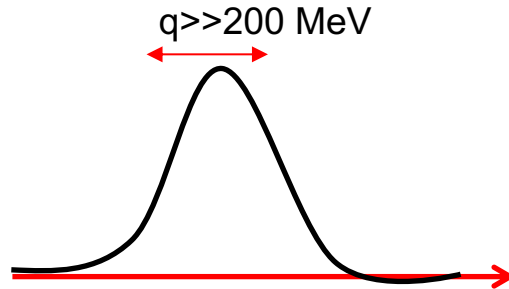

$\sim 1$  GeV neutrino beam  
(T2K, NOvA, HyperK, DUNE)

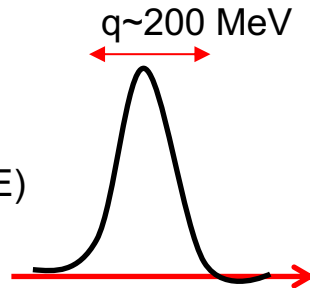

$\gg 1$  GeV neutrino beam  
(IceCube, FASERnu)

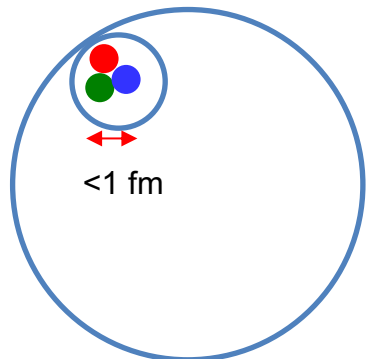
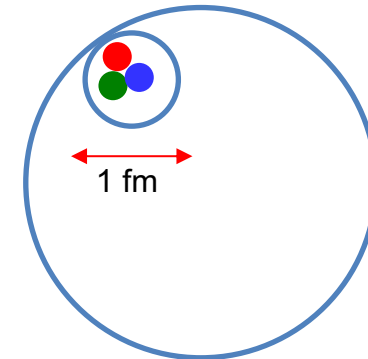
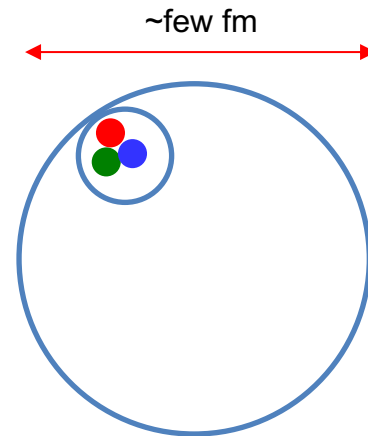
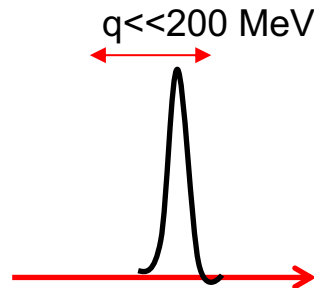

# 1. Scattering measurements

Size of wave packet  $\sim$  momentum transfer ( $\sim$ energy)

$\hbar c = 197 \text{ MeV} \cdot \text{fm} \rightarrow 200 \text{ MeV} \sim 1 \text{ fm}$  (size of nucleon)

Lecture 1: Introduction of neutrino interactions

1. Overview
2. Neutrino lepton scattering (Standard Model)
3. Neutrino quark scattering ( $\nu$ -q scattering)
4. Neutrino nucleus reactions ( $\nu$ -A scattering)

Lecture 2: Neutrino interactions for long baseline oscillation experiments ( $\nu$ -N scattering)

1. Overview
2. CCQE interaction
3. Baryonic resonances
4. Shallow inelastic scattering

## 2. Neutrino-electron scattering

Neutrino – electron differential cross section

$$\frac{d\sigma}{dT} = \frac{2G_F^2 m_e}{\pi} \left[ c_L^2 + c_R^2 \left( \frac{E - T}{E} \right)^2 - c_L c_R \frac{m_e T}{E^2} \right]$$

T=recoil electron kinetic energy

E=neutrino energy

	$C_L$	$C_R$
$\nu_e - e^-$	$\frac{1}{2} + \sin^2\theta_w$	$\sin^2\theta_w$
$\bar{\nu}_e - e^-$	$\sin^2\theta_w$	$\frac{1}{2} + \sin^2\theta_w$
$\nu_\mu - e^-$	$-\frac{1}{2} + \sin^2\theta_w$	$\sin^2\theta_w$
$\bar{\nu}_\mu - e^-$	$\sin^2\theta_w$	$-\frac{1}{2} + \sin^2\theta_w$

## 2. MINERvA neutrino flux tuning

Neutrino – electron differential cross section

$$\frac{d\sigma}{dT} = \frac{2G_F^2 m_e}{\pi} \left[ c_L^2 + c_R^2 \left( \frac{E - T}{E} \right)^2 - C_L C_R \frac{m_e T}{E^2} \right]$$

T=recoil electron kinetic energy

E=neutrino energy

$$\#events = \left( \int flux \otimes cross\ section \otimes efficiency \right) \times target\ number \times exposure$$

By assuming detector efficiency and cross-section are known, you can measure neutrino flux

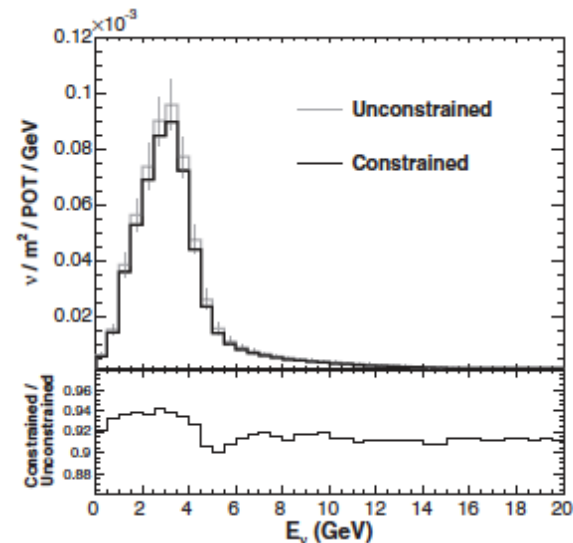
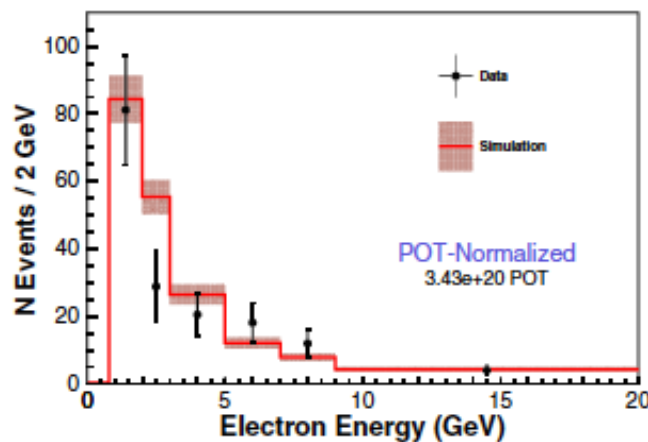



## 2. Neutrino magnetic moment

Neutrino – electron differential cross section

$$\frac{d\sigma}{dT} = \frac{2G_F^2 m_e}{\pi} \left[ c_L^2 + c_R^2 \left( \frac{E - T}{E} \right)^2 - C_L C_R \frac{m_e T}{E^2} \right]$$

T=recoil electron kinetic energy

E=neutrino energy

Neutrino – electron differential cross section with neutrino magnetic moment

$$\frac{d\sigma}{dT} = \frac{2G_F^2 m_e}{\pi} \left[ c_L^2 + c_R^2 \left( \frac{E - T}{E} \right)^2 - C_L C_R \frac{m_e T}{E^2} \right] + \frac{\pi \alpha \mu_\nu^2}{m_e^2} \left( \frac{1}{T} - \frac{1}{E} \right)$$

SM

large neutrino magnetic moment (BSM)

Lepton-only process (pure Standard Model) is often used to test new physics

TEXONO (Taiwan)

- reactor neutrino

- ES:  $\bar{\nu}_e + e \rightarrow \bar{\nu}_e + e$

- CsI (TI) crystal

array (187kg)

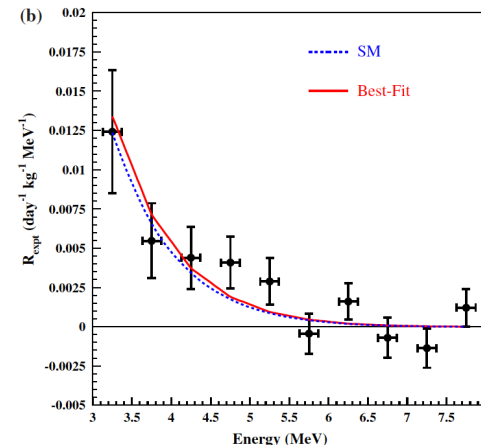
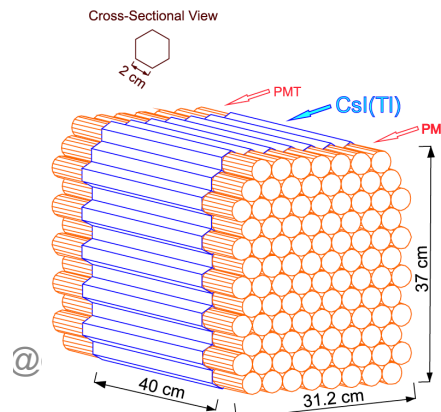
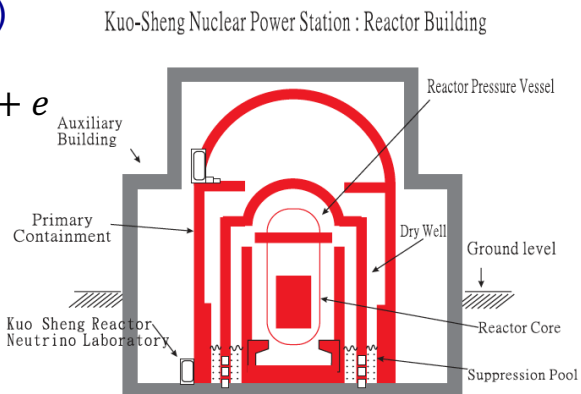

### 3. Neutrino-DIS cross section

Neutrino – single d-quark cross section

$$\frac{d\sigma}{dy}(vd \rightarrow \mu u) = \frac{G_F^2 xS}{\pi}$$

Neutrino – d-quark cross section

$$\frac{d\sigma}{dy}(vd \rightarrow \mu u) = \int_0^1 \frac{G_F^2 xS}{\pi} d(x) dx$$

Neutrino-nucleon DIS cross section

$$\frac{d\sigma}{dy}(vN \rightarrow \mu X) = \int_0^1 \frac{G_F^2 xS}{\pi} [(d(x) + s(x) \dots) + [\bar{u}(x) + \bar{c}(x) \dots]](1 - y)^2 dx$$

Neutrino-nucleus DIS cross section with **isoscalar** assumption

$$\frac{d\sigma}{dy}(vA \rightarrow \mu X) = A \int_0^1 \frac{G_F^2 xS}{\pi} [Q(x) + \bar{Q}(x)(1 - y)^2] dx$$

$$u^p(x) + u^n(x) = d^n(x) + d^p(x) = u(x) + d(x) \equiv Q(x)$$

$$\bar{u}^p(x) + \bar{u}^n(x) = \bar{u}^n(x) + \bar{u}^p(x) = \bar{u}(x) + \bar{d}(x) \equiv \bar{Q}(x)$$

# 3. Di-muon production

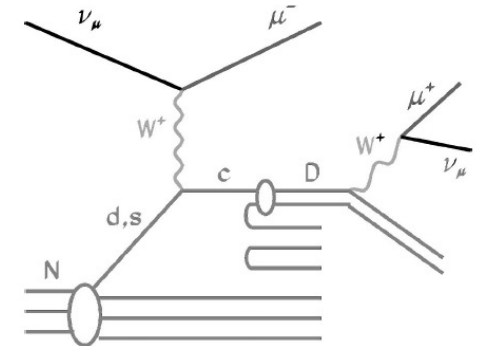
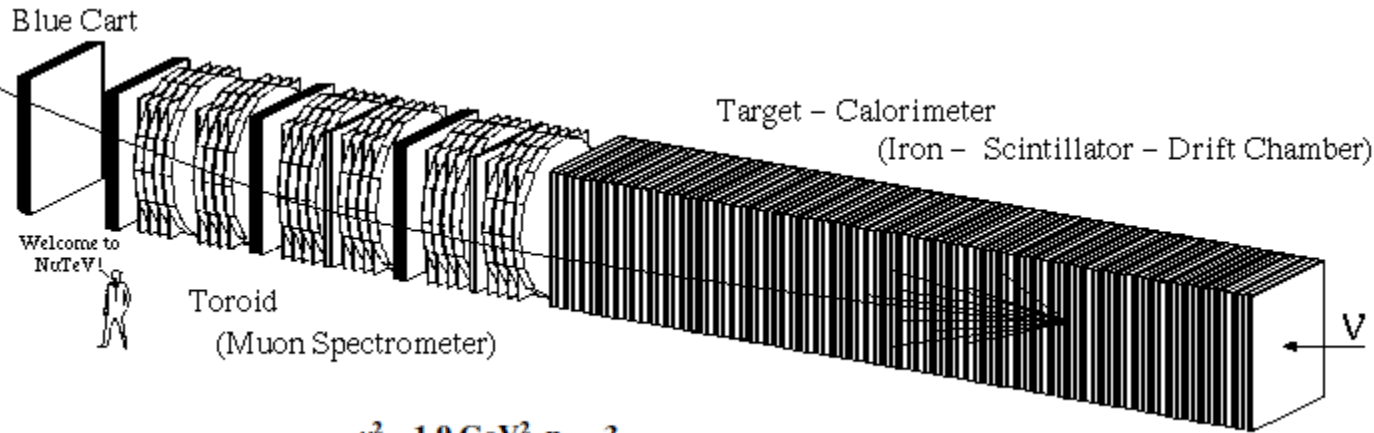

$\mu^2 = 1.9 \text{ GeV}^2, n_f = 3$

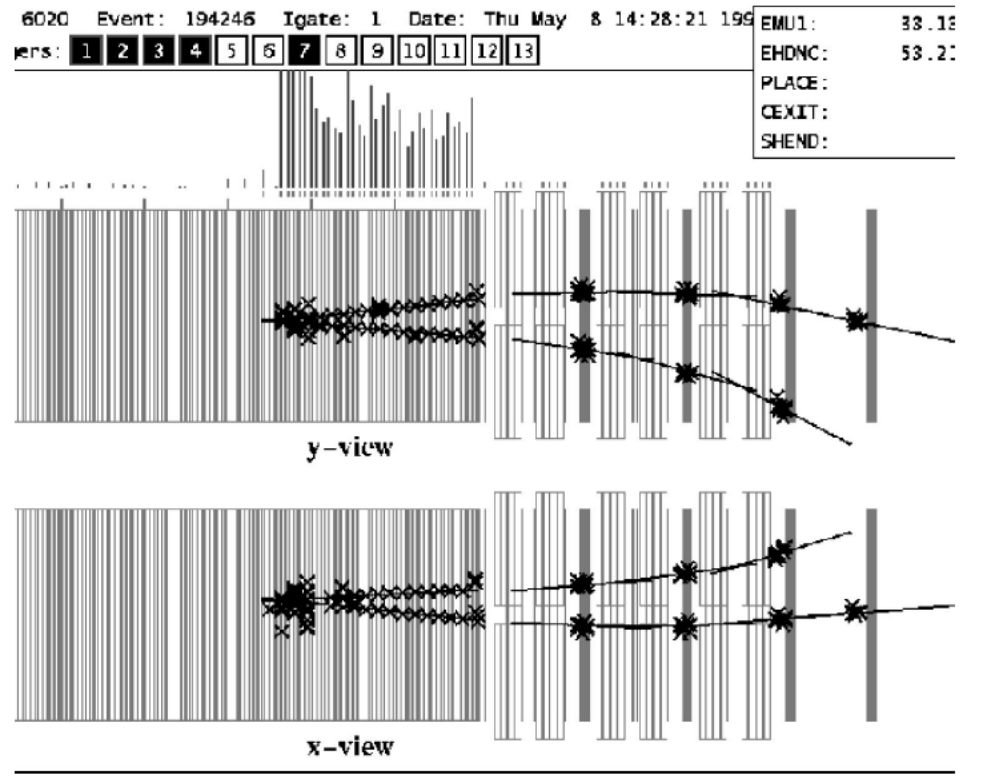
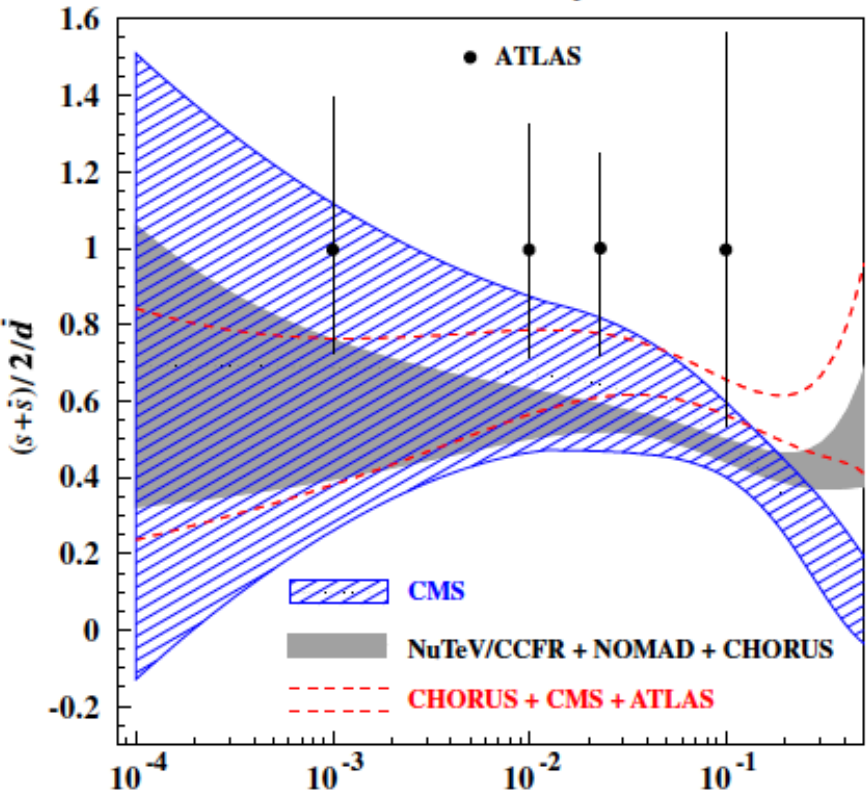

# 3. Paschos-Wolfenstein ratio and NuTeV anomaly



Manny Paschos  
(Dortmund)

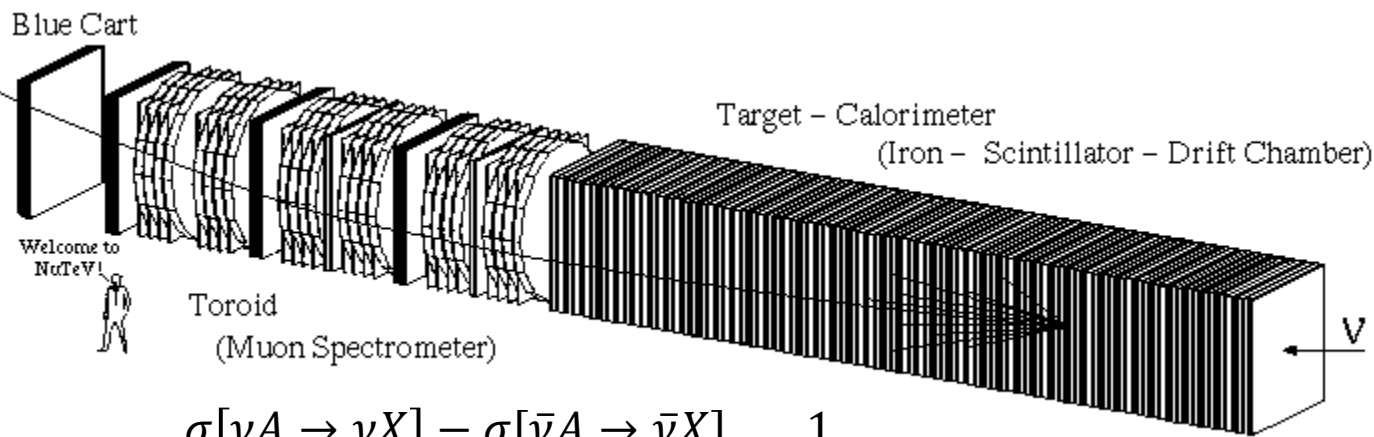

$$R_{PW} = \frac{\sigma[\nu A \rightarrow \nu X] - \sigma[\bar{\nu} A \rightarrow \bar{\nu} X]}{\sigma[\nu A \rightarrow \mu X] - \sigma[\bar{\nu} A \rightarrow \mu^+ X]} = \frac{1}{2} - \sin^2 \theta_W$$

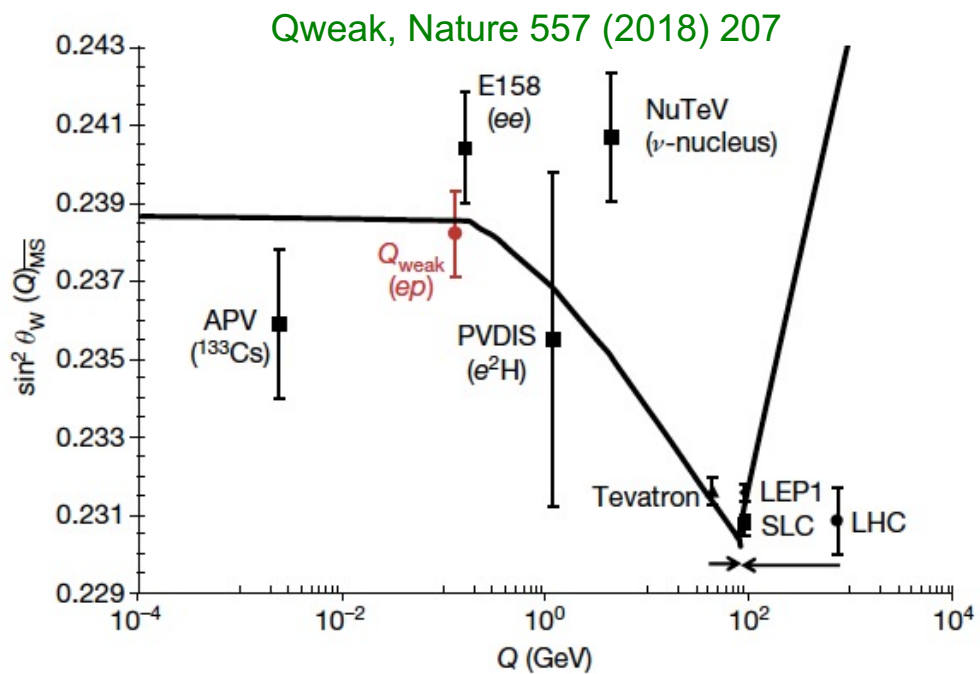

### 3. Astrophysical high-energy neutrino measurement

Data and MC agree up to  $\sim$ PeV.  
 $\rightarrow$  We more or less understand neutrino interactions up to  $\sim$ PeV.

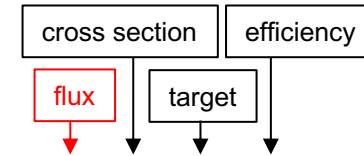

$$\text{Event rate } N = \Phi \times \sigma \times T \times \varepsilon$$

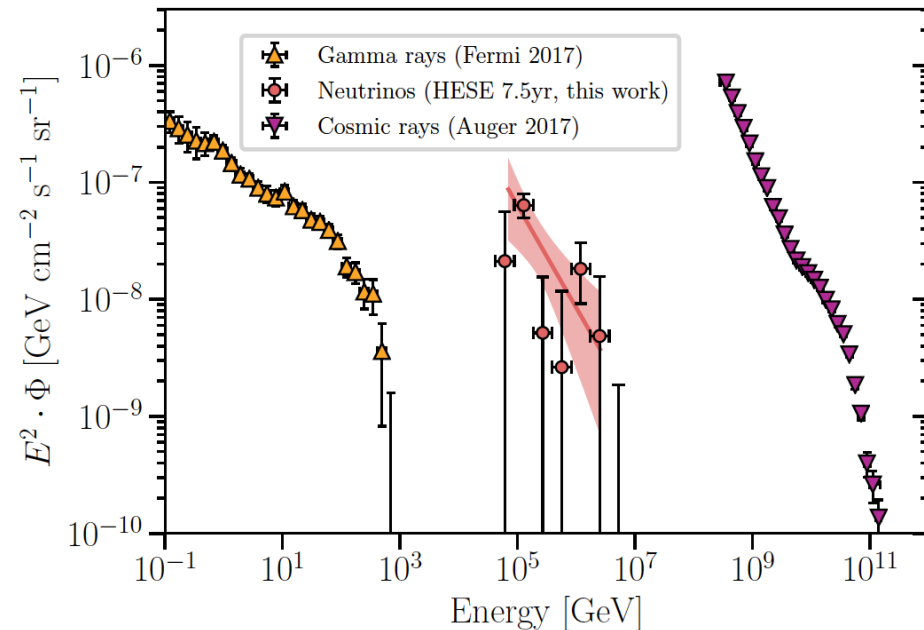
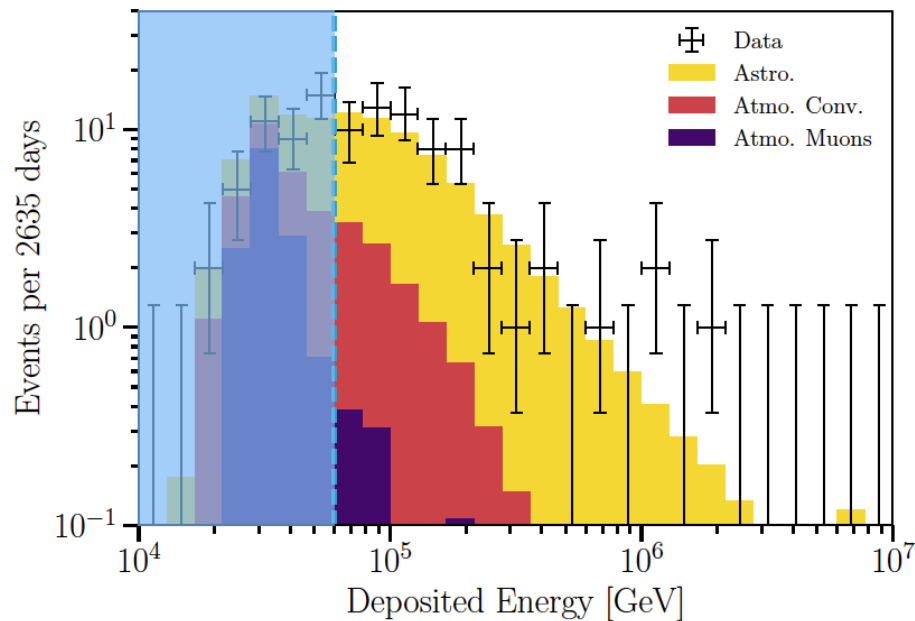

# 3. Neutrino DIS saturation

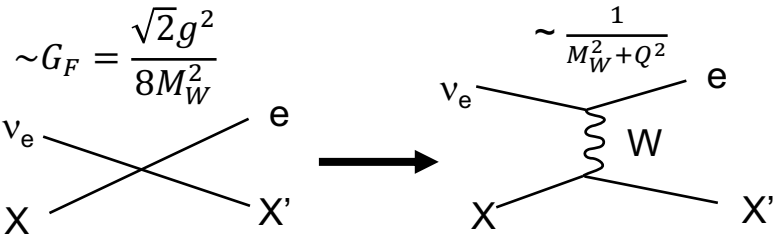

cross section      efficiency

flux      target

Event rate  $N = \Phi \times \sigma \times T \times \epsilon$

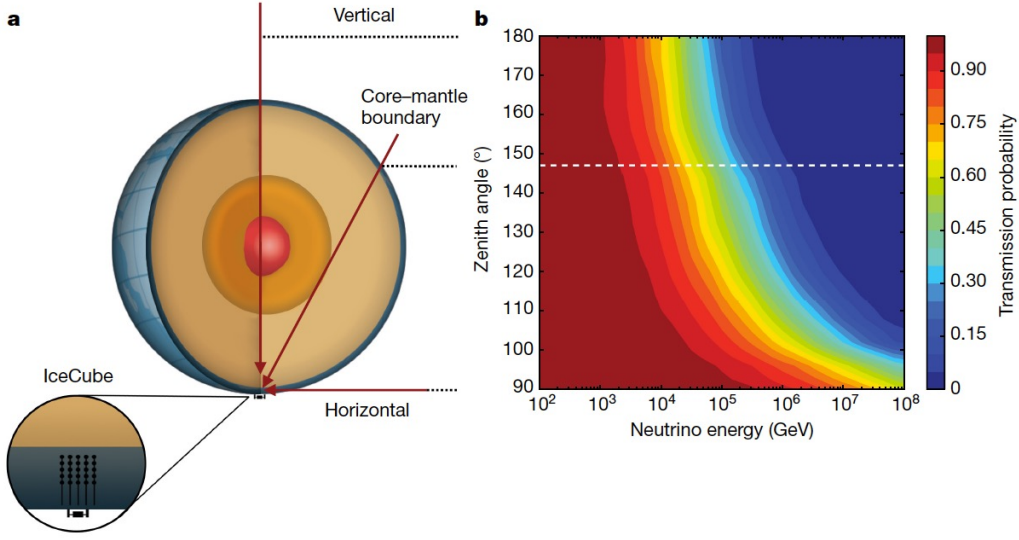
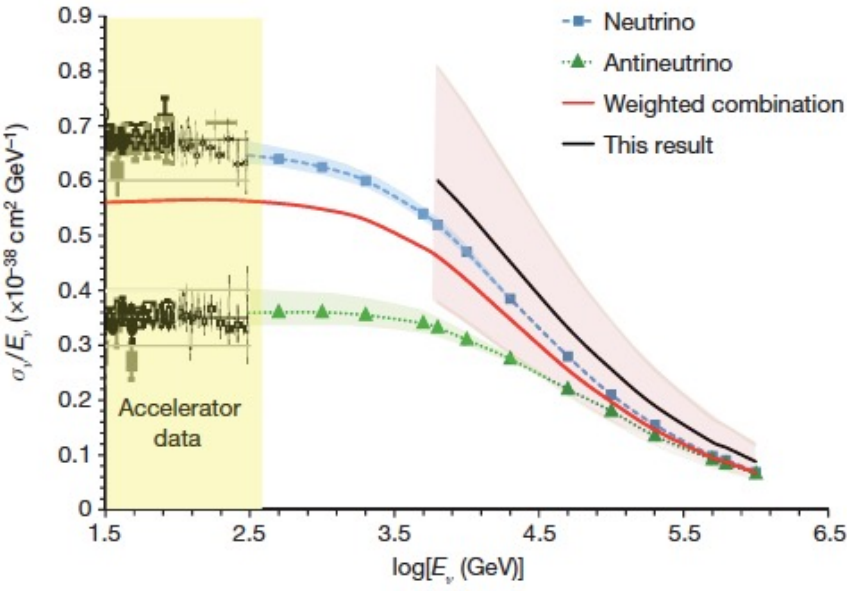

# 3. Earth tomography

## Earth absorption for Earth density measurement

- PREM (Preliminary reference Earth model)
- Standard earth density model used by T2K, NOvA, etc
- Earth density profile is extracted by assuming flux and cross section
- Measure Earth moment of inertia and Earth mass by neutrinos

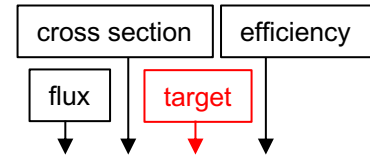
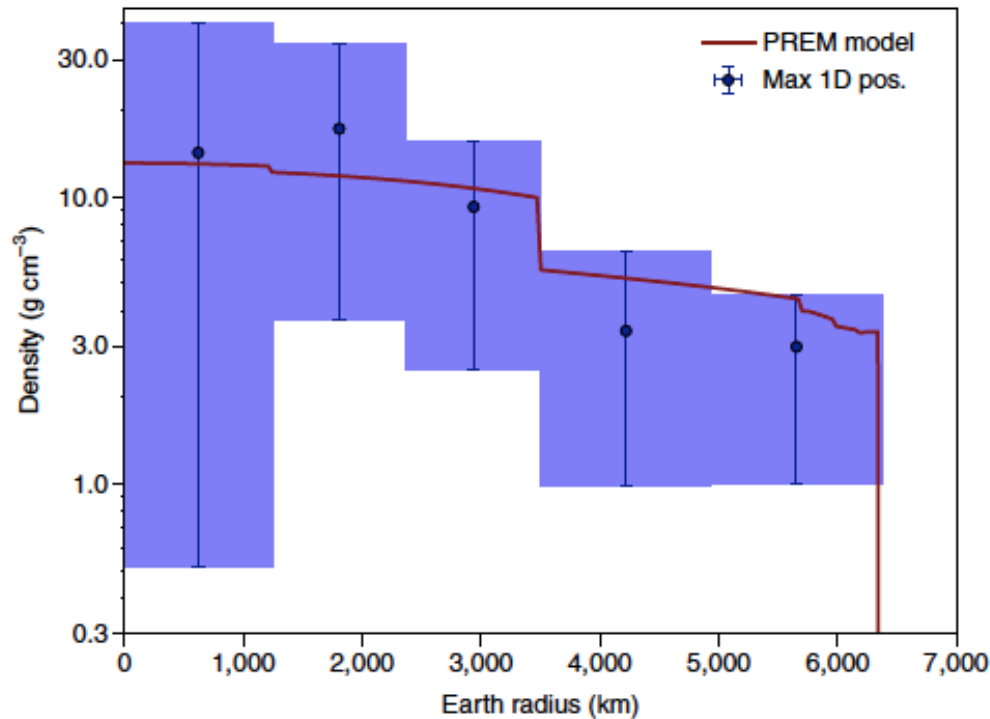

$$\text{Event rate } N = \Phi \times \sigma \times T \times \epsilon$$

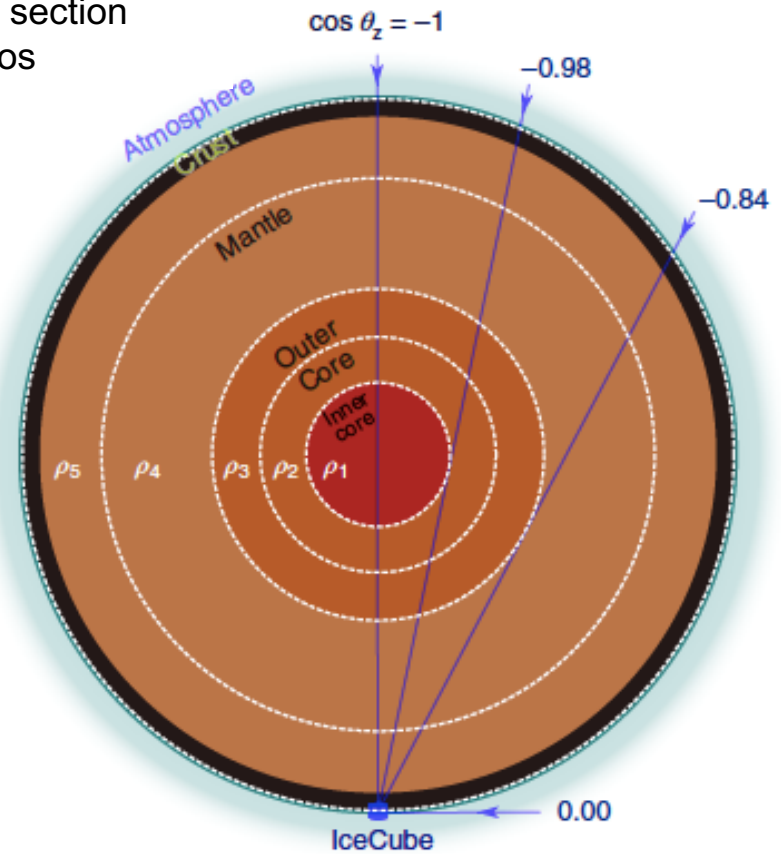

### 3. Glashow resonance

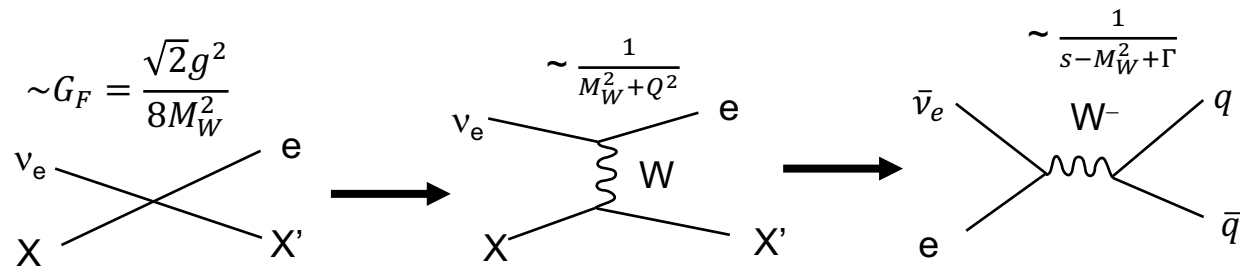

## A 5.9 PeV event in IceCube

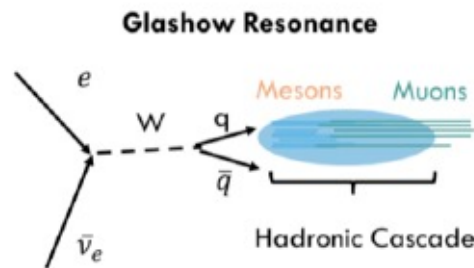

Resonance:  $E_\nu = 6.3$  PeV  
 Typical visible energy is 93%

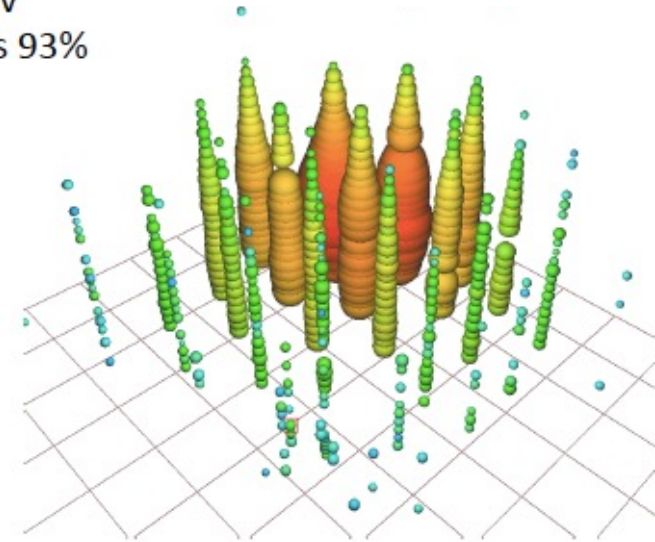
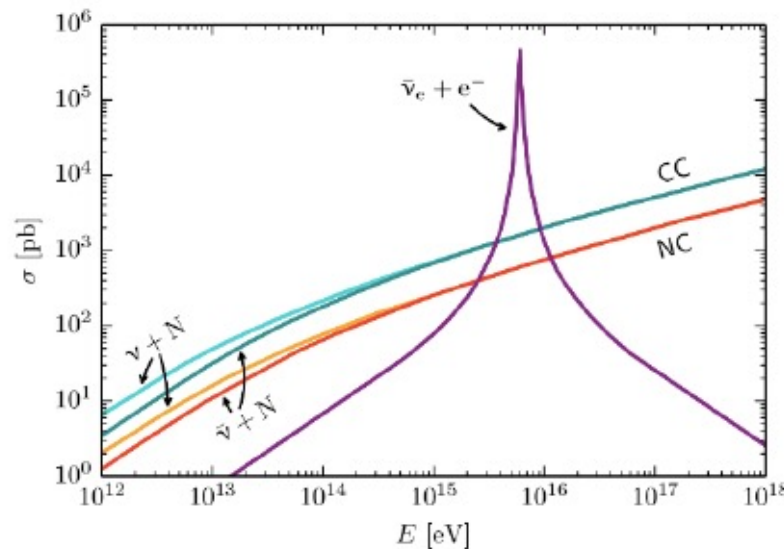

Event identified in a partially-contained PeV search (PEPE)

Deposited energy:  $5.9 \pm 0.18$  PeV (stat only)

ICRC 2017 arXiv:1710.01191



# 3. Collider neutrino

## FASERnu

- Emulsion detector (high-resolution)
- neutrinos from ATLAS collision point
- neutrino excess from pilot run
- ~10,000 neutrino events from LHC run 3
- 12 events in the emulsion detector

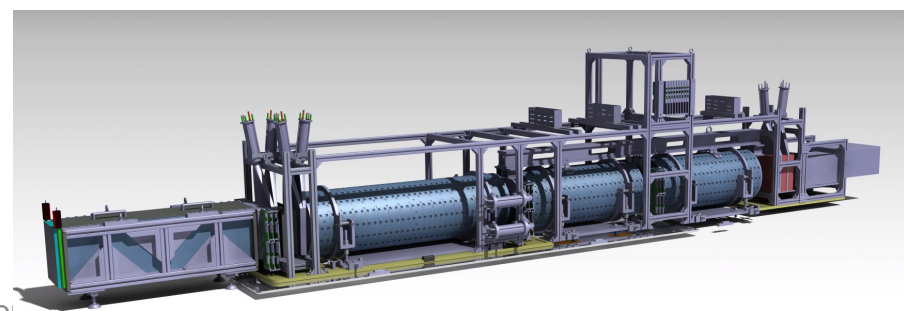
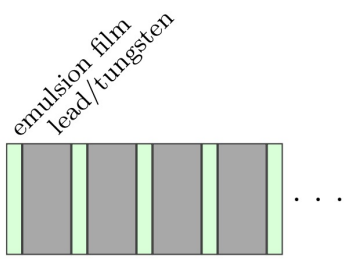
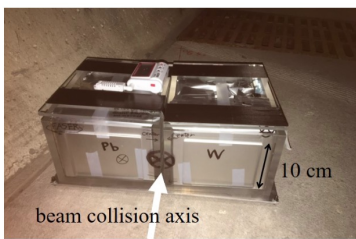
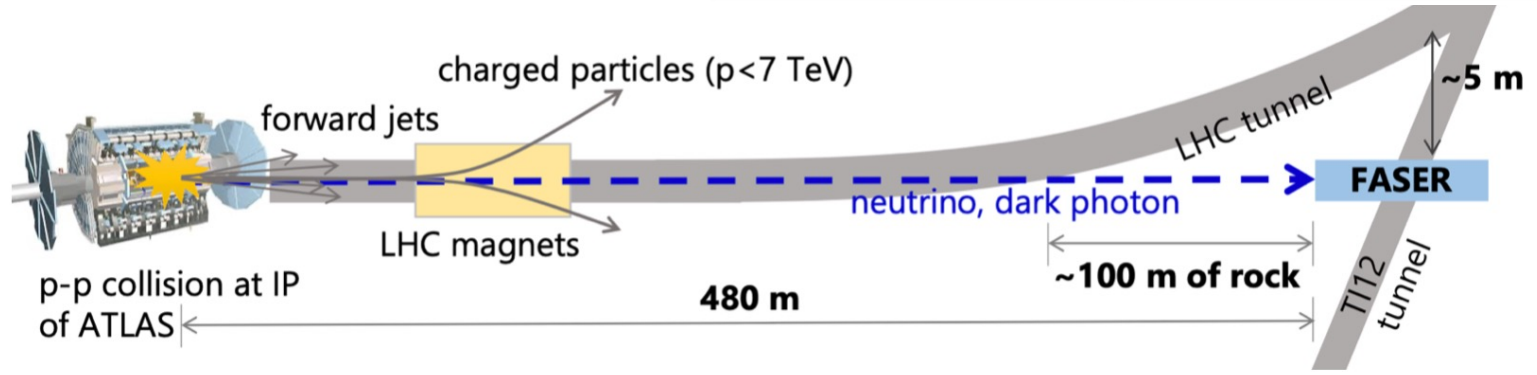
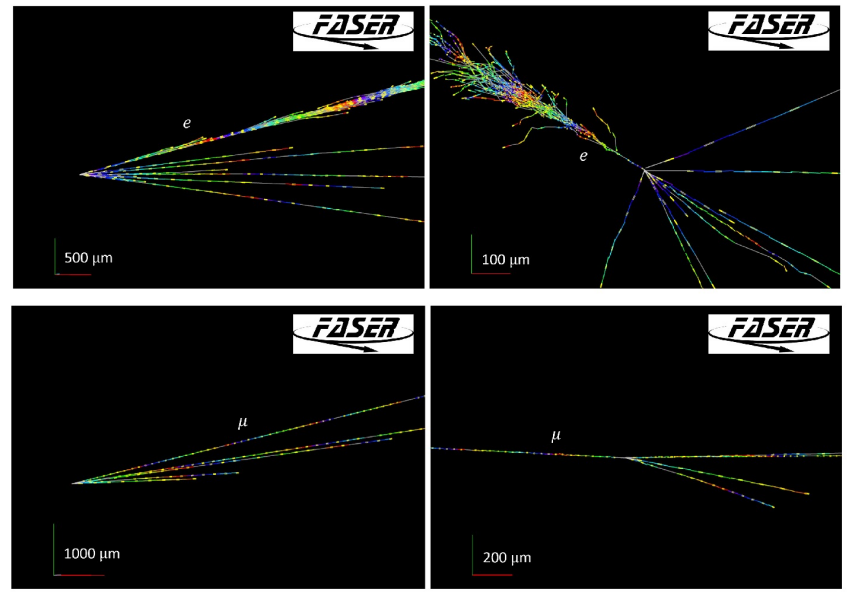

## 4. Reactor neutrino

### Low energy electron anti-neutrinos

- High-precision spectrum prediction
- Monitoring fission reactor

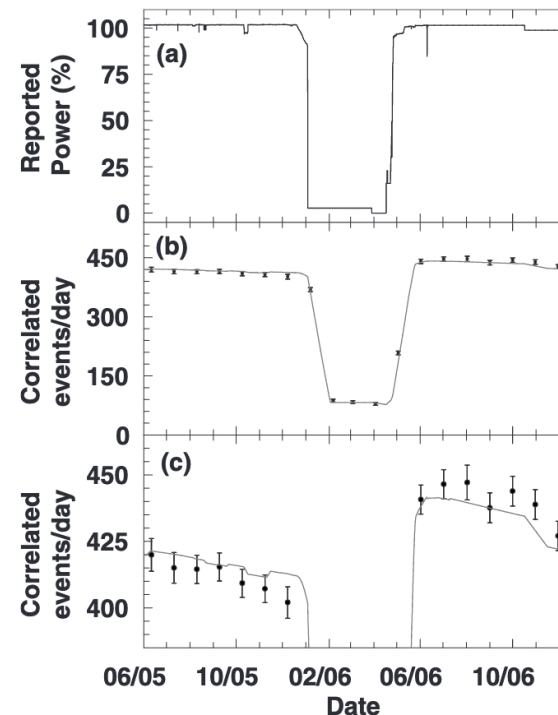
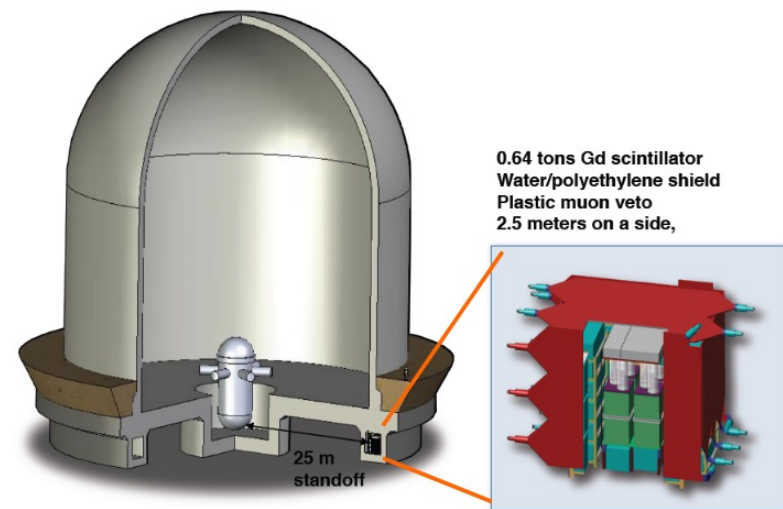
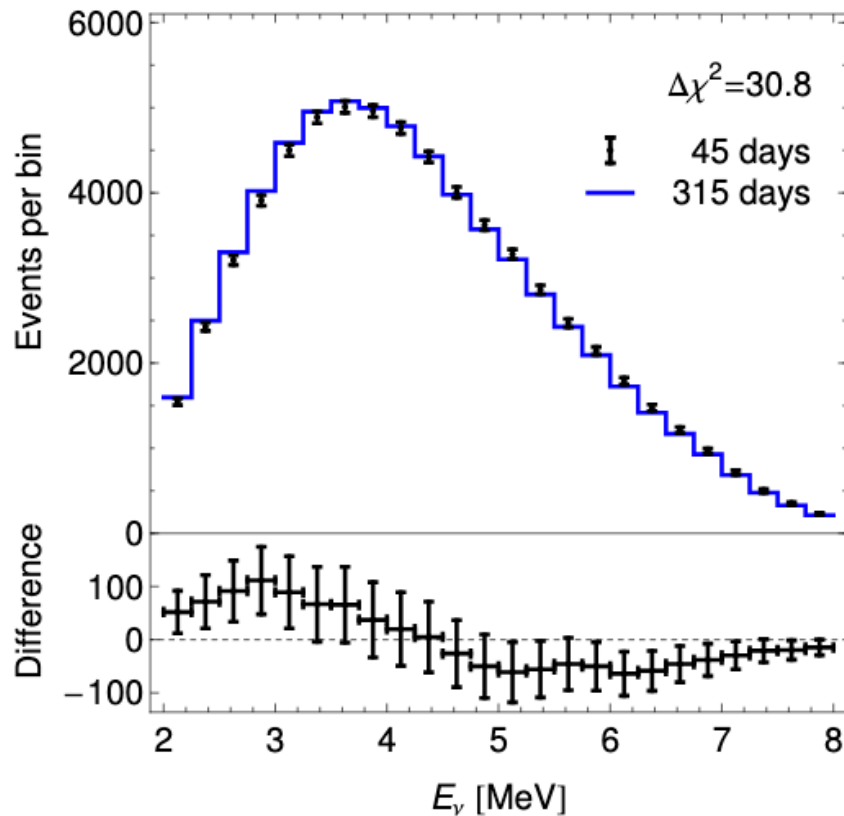

# 4. Solar neutrino

## Homestake experiment



(proposed by Pontecorvo)

- mainly sensitive to  ${}^8\text{B}$  neutrino (~10 MeV)

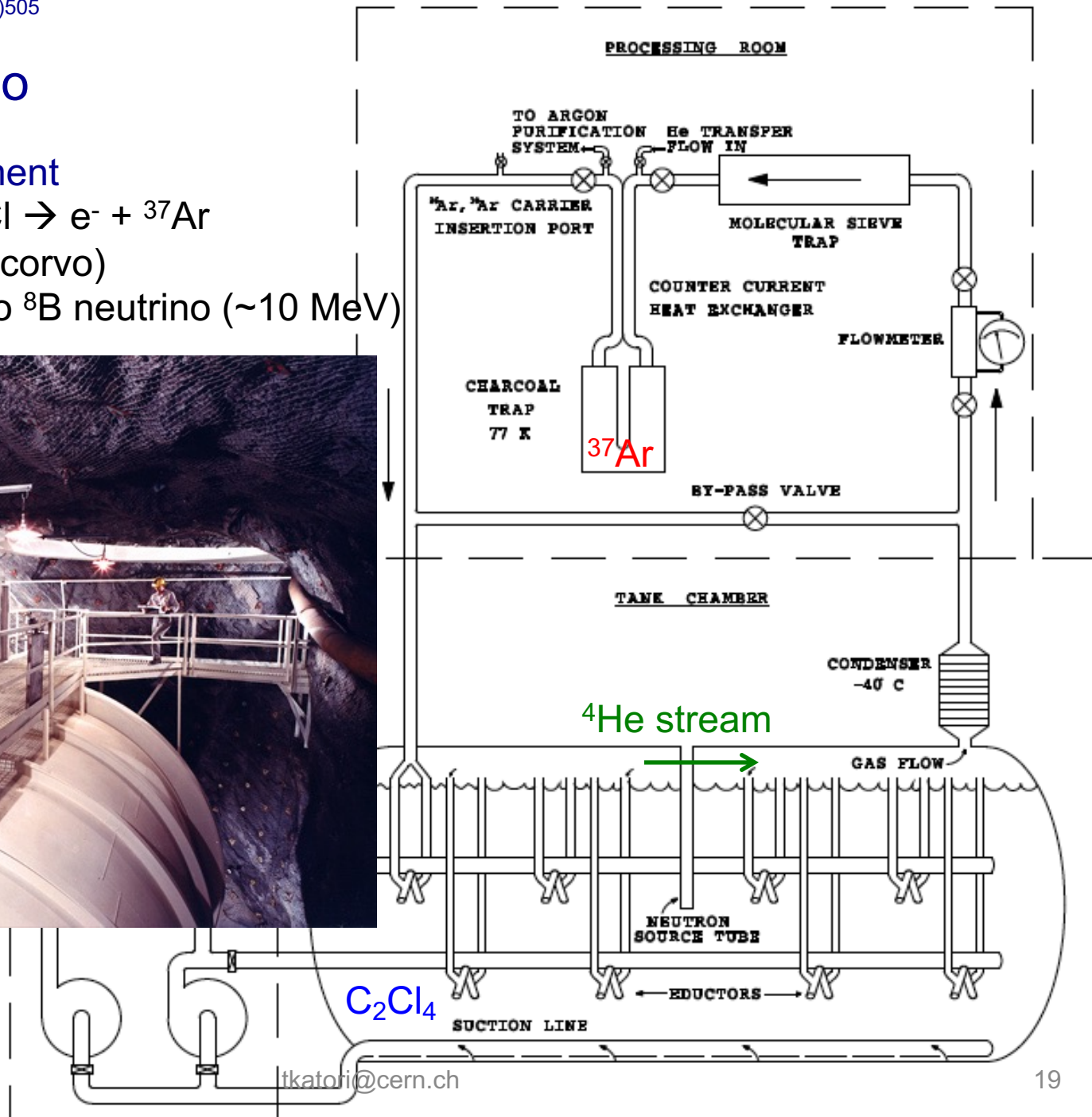

# 4. Solar neutrino

## Gallium experiment

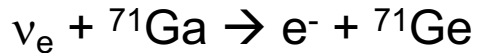

- Sensitive to pp-neutrino (0.42 MeV),  
 90% of total solar neutrino flux.

- Both experiments observed deficit,  
 but higher than Homestake result

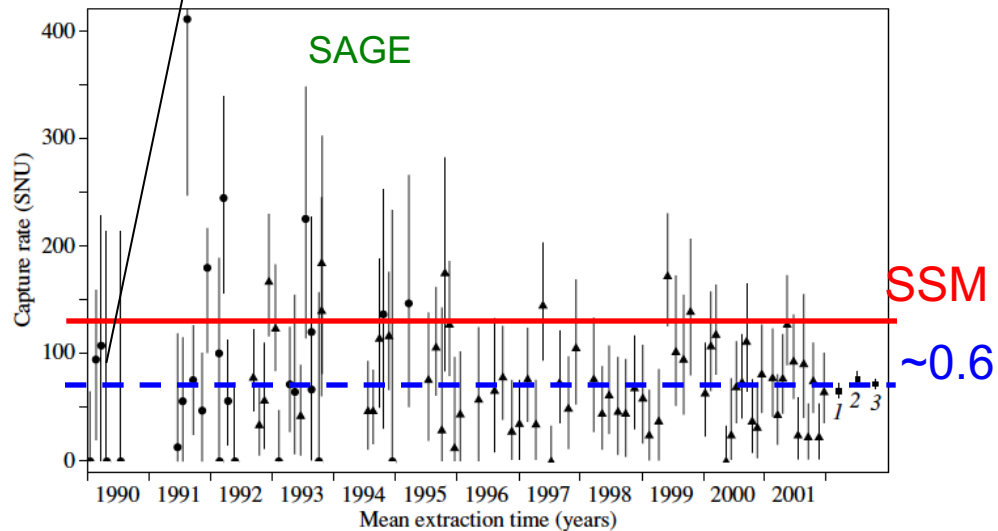
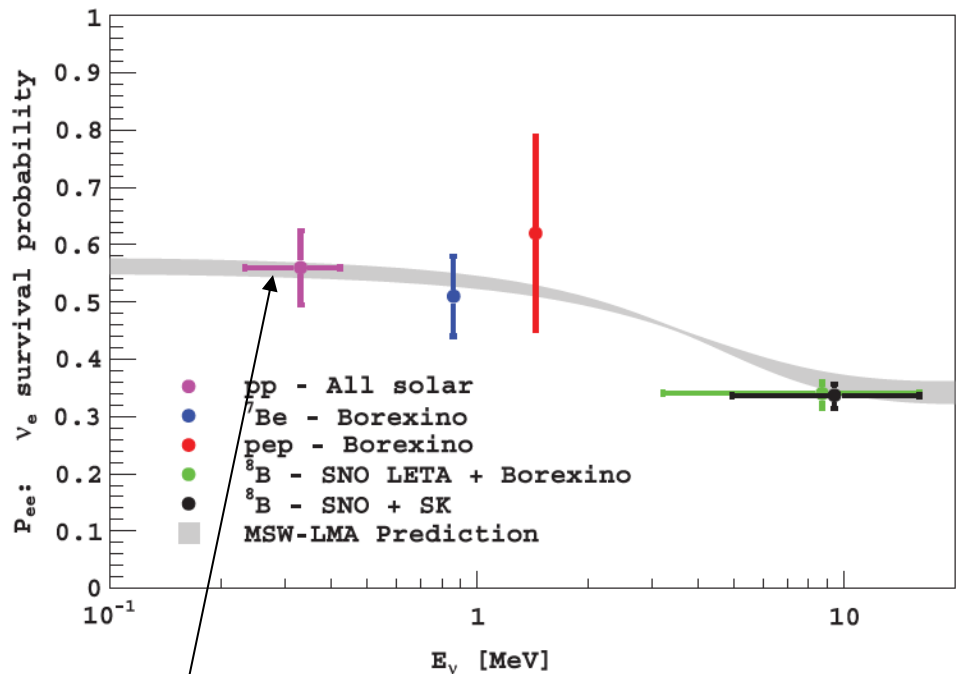
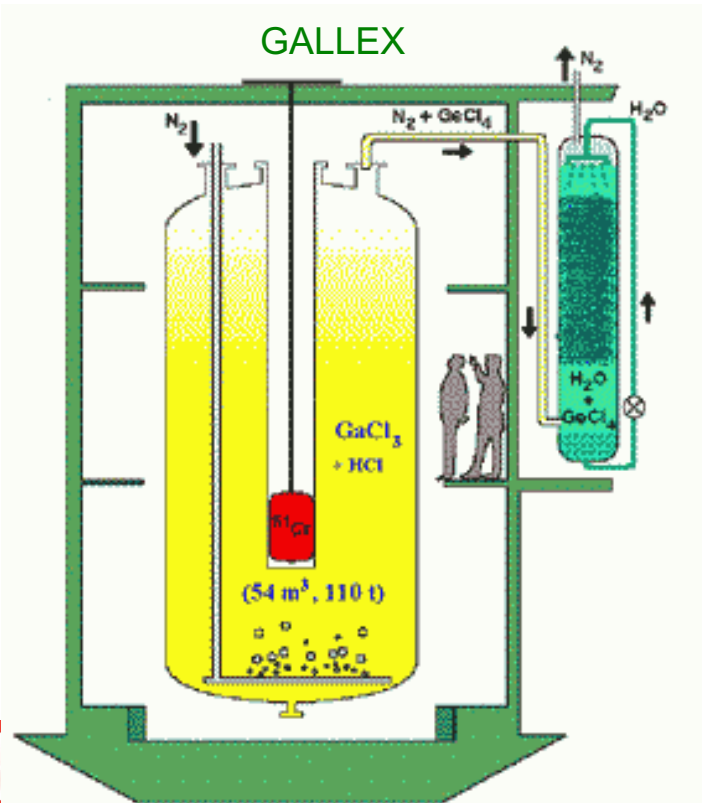

# 4. Neutrino-Nucleus coherent scattering

Low energy neutrinos from neutron sources at SNS (spallation neutron source), ORNL (Oak Ridge National Lab)



Science

REPORTS

Cite as: D. Akimov et al., Science 10.1126/science.aao0990 (2017).

## Observation of coherent elastic neutrino-nucleus scattering

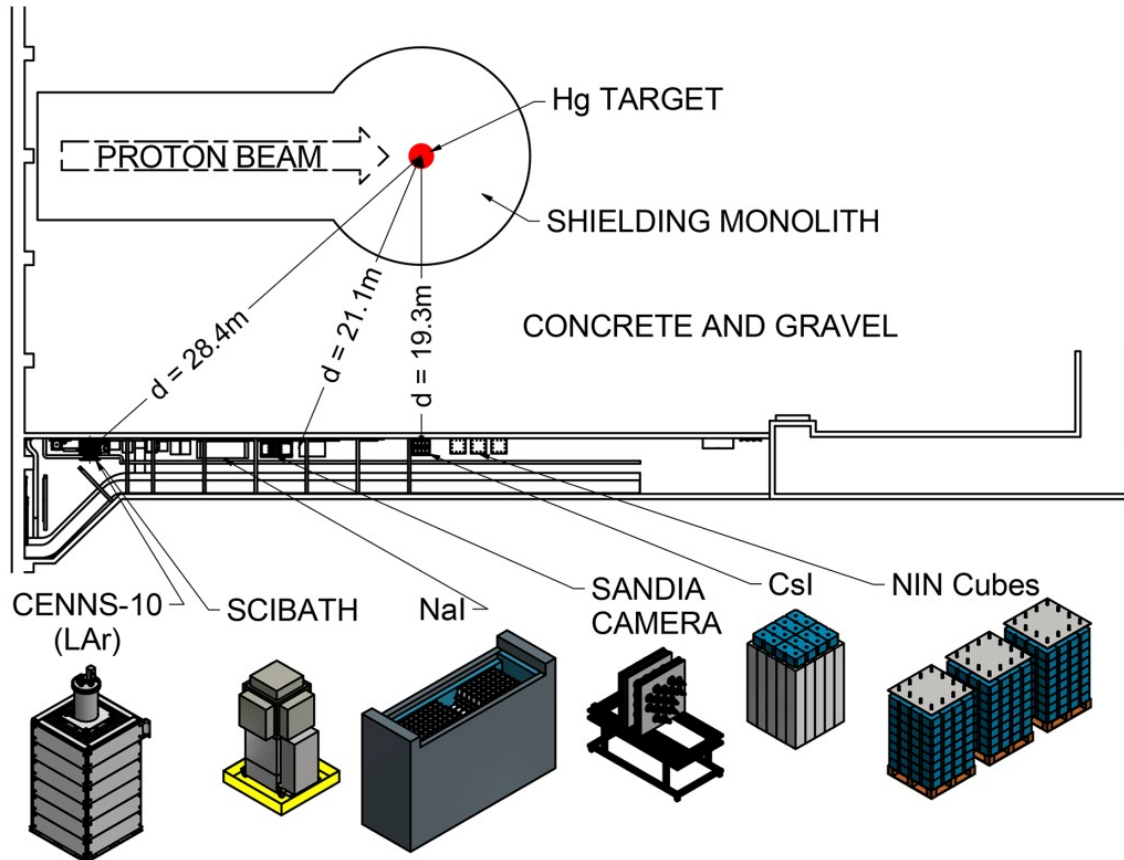
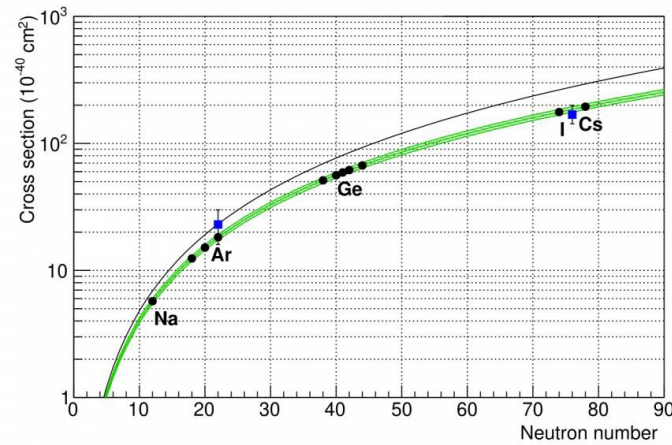

# Conclusion

$\nu$ -l scattering : well-known, test of weak theory

Neutrino-electron scattering for neutrino flux measurement

Anti-electron neutrino scattering for neutrino magnetic moment search (BSM)

$\nu$ -q scattering : test of weak theory, test of quark model

DIS cross sections

Di-muon production

Paschos-Wolfenstein ratio

Astrophysical neutrinos

collider neutrinos

$\nu$ -A scattering :

Reactor neutrino experiments

Neutrino nuclear capture by Cl and Ga, important for solar neutrinos

Neutrino coherent scattering, important for supernova (2017)

$\nu$ -N scattering : important reactions for long baseline neutrino oscillation experiment  
(T2K, NOvA, DUNE, Hyper-Kamiokande)

# Neutrino Interaction Physics

## Lecture 1: Introduction of neutrino interactions

1. Overview
2. Neutrino lepton scattering
3. Neutrino quark scattering (DIS)
4. Neutrino nucleus reactions

## Lecture 2: Neutrino interactions for long baseline oscillation experiments

1. Overview
2. CCQE interaction
3. Baryonic resonances
4. Shallow inelastic scattering (SIS)

Teppei Katori  
King's College London  
Oct. 08, 2024

Subscribe “NuSTEC-News”  
[nustec.fnal.gov](http://nustec.fnal.gov)  
like “NuSTEC-News” on Facebook page  
use hashtag #nuxsec

# 1. From eV to EeV: Neutrino cross sections across energy scales

lecture 1: Everything not relevant with long-baseline neutrino oscillation experiments  
lecture 2: nuxsec for long-baseline neutrino oscillation experiments (DUNE, HyperK)

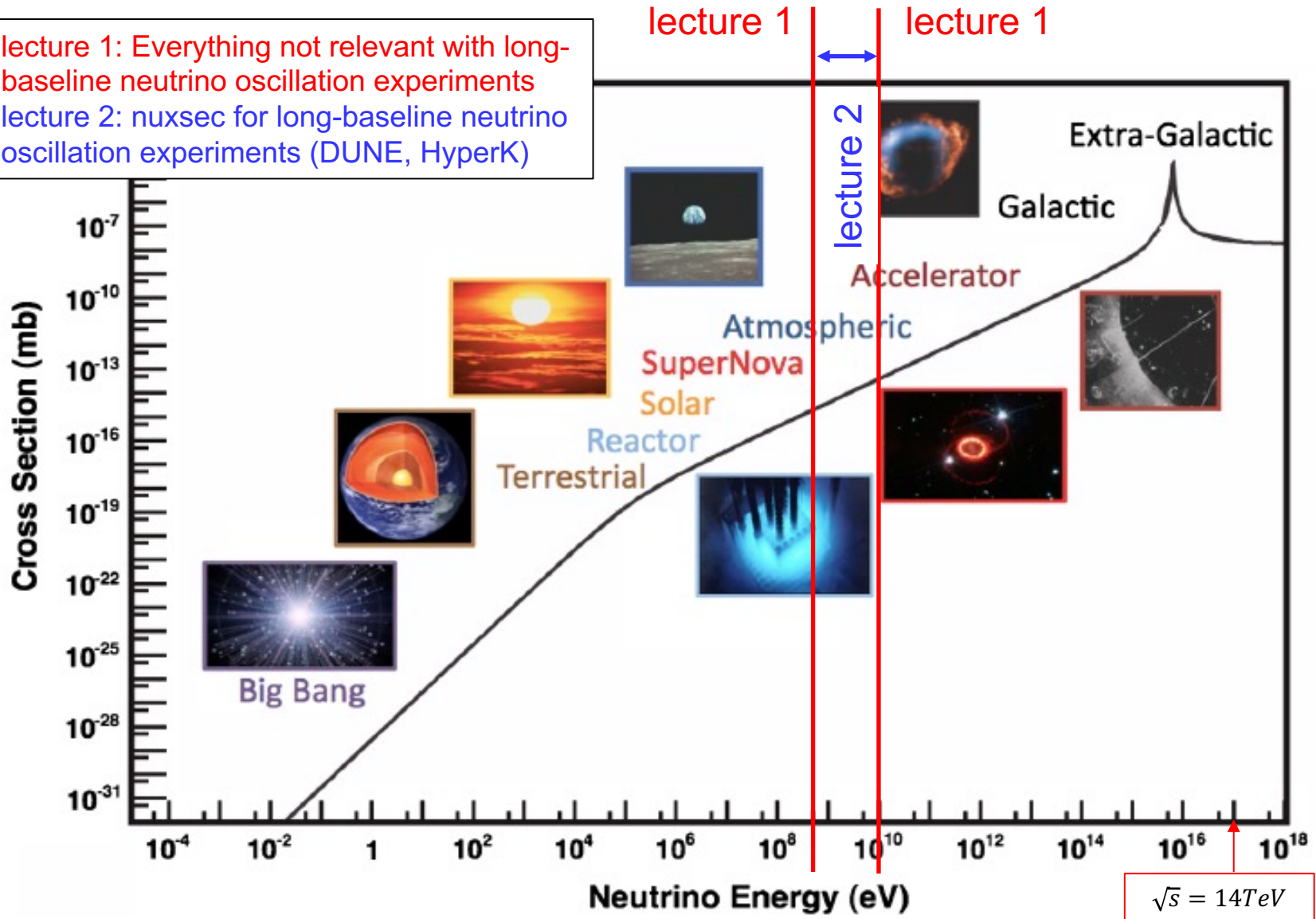

$\sqrt{s} = 14TeV$



# 1. Next generation neutrino oscillation experiments

## Accelerator-based neutrino oscillation experiments

- Present to Future: T2K, NOvA, Hyper-Kamiokande, DUNE

### Quasi Elastic

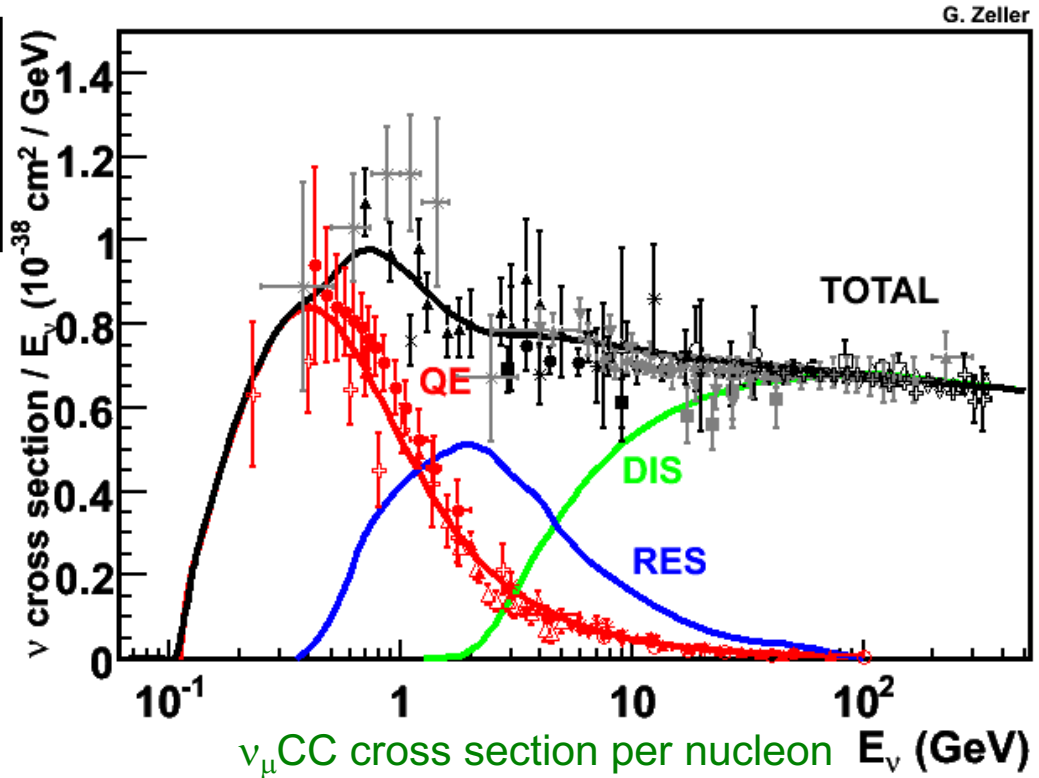
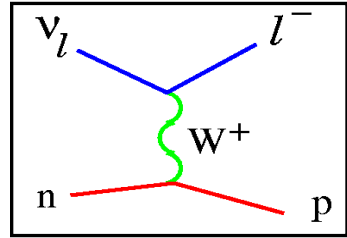

### baryonic RESonance

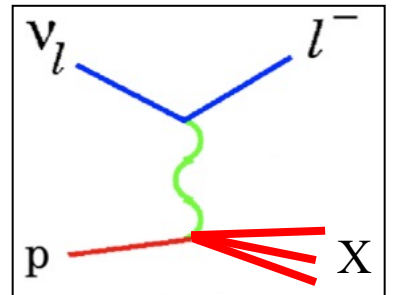
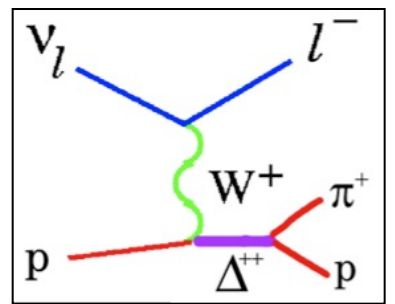

### Deep Inelastic Scattering



# 1. Next generation neutrino oscillation experiments

## Accelerator-based neutrino oscillation experiments

- Present to Future: T2K, NOvA, Hyper-Kamiokande, DUNE...

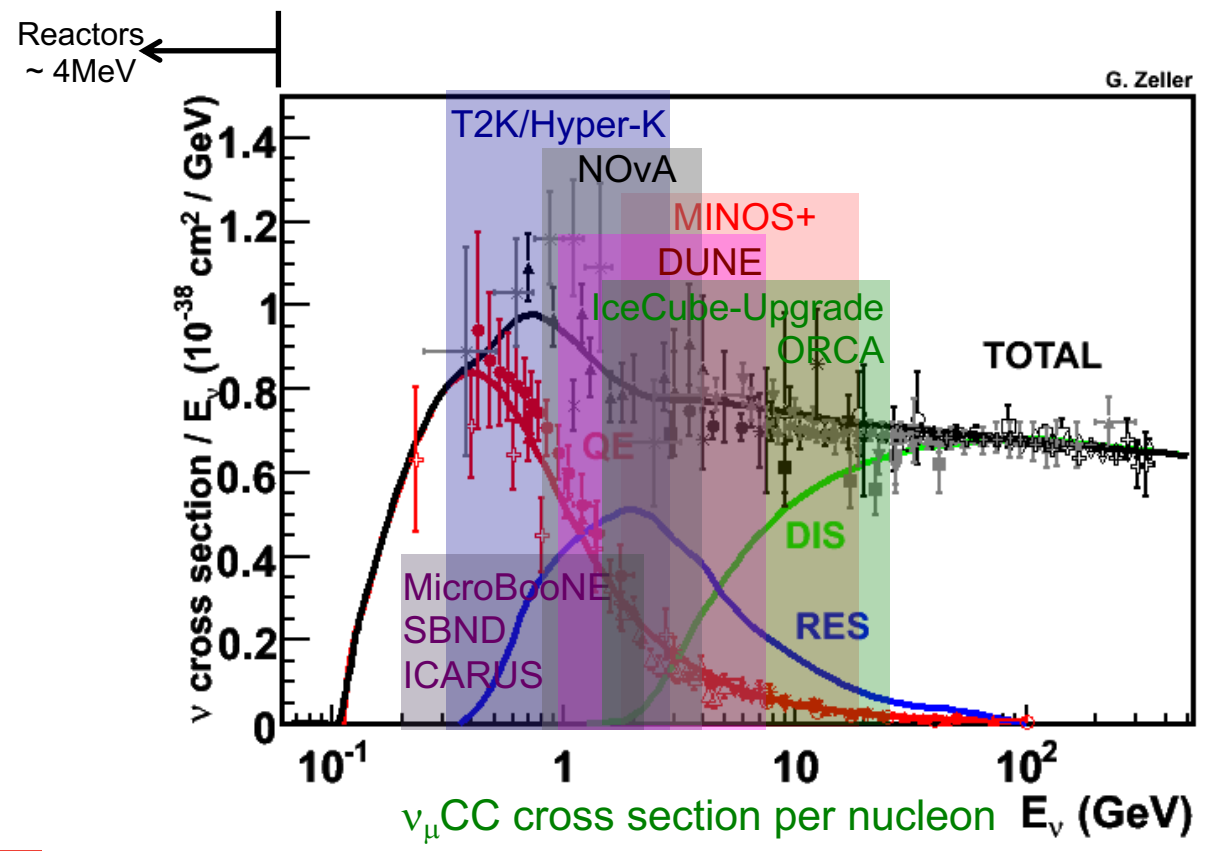

$$P_{\mu \rightarrow e}(L/E) = \sin^2 2\theta \sin^2 \left( 1.27 \Delta m^2 (eV^2) \frac{L(km)}{E(GeV)} \right)$$

# 1. Next generation neutrino oscillation experiments

## Accelerator-based neutrino oscillation experiments

- Present to Future: T2K, NOvA, Hyper-Kamiokande, DUNE...

## Most of data are from muon neutrino beam

- create by  $\pi$ -DIF, K-DIF (pion and kaon decay-in-flight)
- $\Phi(\nu_\mu) > \Phi(\bar{\nu}_\mu)$ : more  $\pi^+$  and  $K^+$  than  $\pi^-$  and  $K^-$  (for low energy accelerators)
- $\mu$ -decay can make electro-neutrinos but they are background
- $\delta_{CP}$  study need electro-neutrino and antineutrino cross-sections ( $\nu_e$  appearance)

## Nuclear physics

- Simple extrapolation may be broken due to nuclear physics
- We are not good at nuclear physics because we are not nuclear physicists
- Nuclear physics = non-perturbative QCD (many models, no theory)
- Particle physics is developed by avoiding nuclear physics...

$$P_{\mu \rightarrow e}(L/E) = \sin^2 2\theta \sin^2 \left( 1.27 \Delta m^2 (eV^2) \frac{L(km)}{E(GeV)} \right)$$

# 1. Particle Physics vs. Nuclear Physics

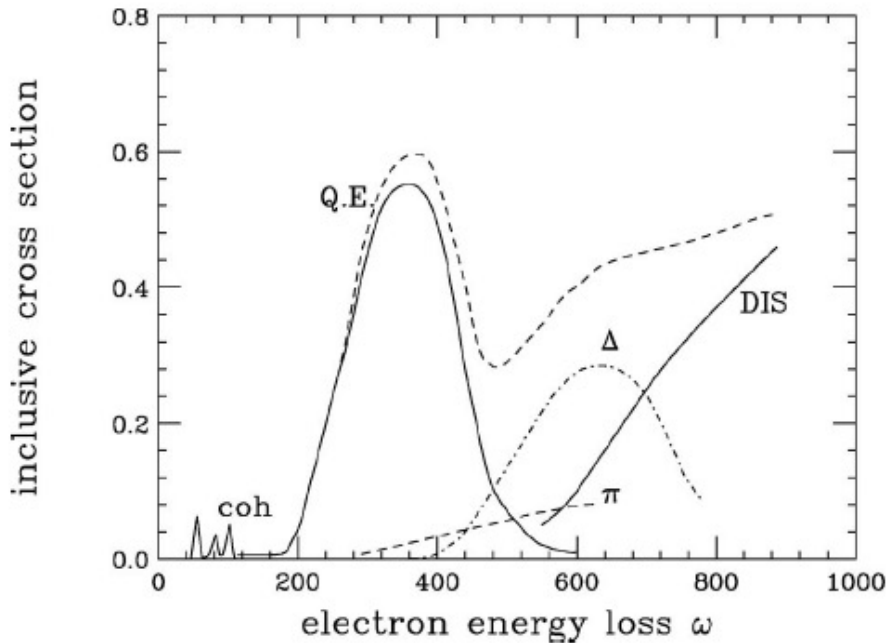

## Nuclear physics

Interactions are classified in  $q$  (3-momentum transfer) and  $\omega$  (energy transfer)

## Particle physics (neutrino physics)

Interactions are classified in  $Q^2$  (4-momentum transfer) and  $\nu$  (energy transfer) or  $W^2$  (invariant mass)

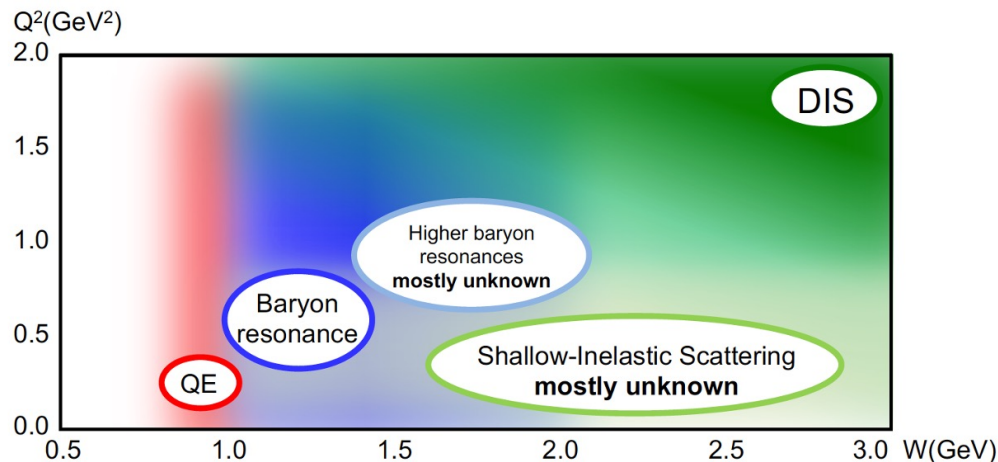

# 1. Neutrino cross-section formula

## Cross-section

- product of Leptonic and Hadronic tensor

$$d\sigma \sim L^{\mu\nu}W_{\mu\nu}$$

## Leptonic tensor

→ the Standard Model (easy)

## Hadronic tensor

→ nuclear physics (hard)

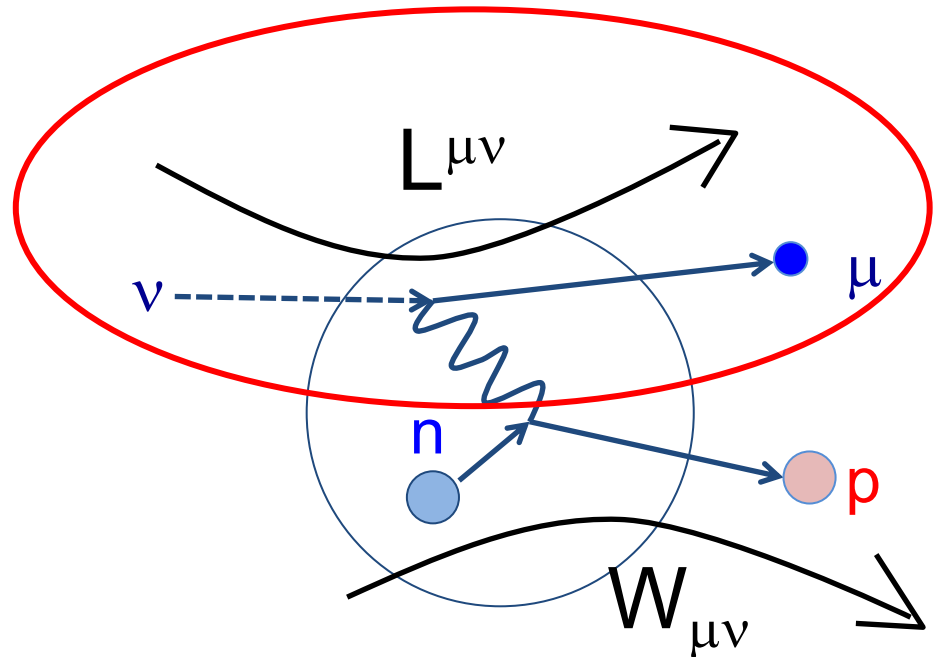

# 1. Neutrino cross-section formula

## Cross-section

- product of Leptonic and Hadronic tensor

$$d\sigma \sim L^{\mu\nu}W_{\mu\nu}$$

Leptonic tensor

→ the Standard Model (easy)

Hadronic tensor

→ nuclear physics (hard)

All complication of neutrino cross-section is how to model the hadronic tensor part

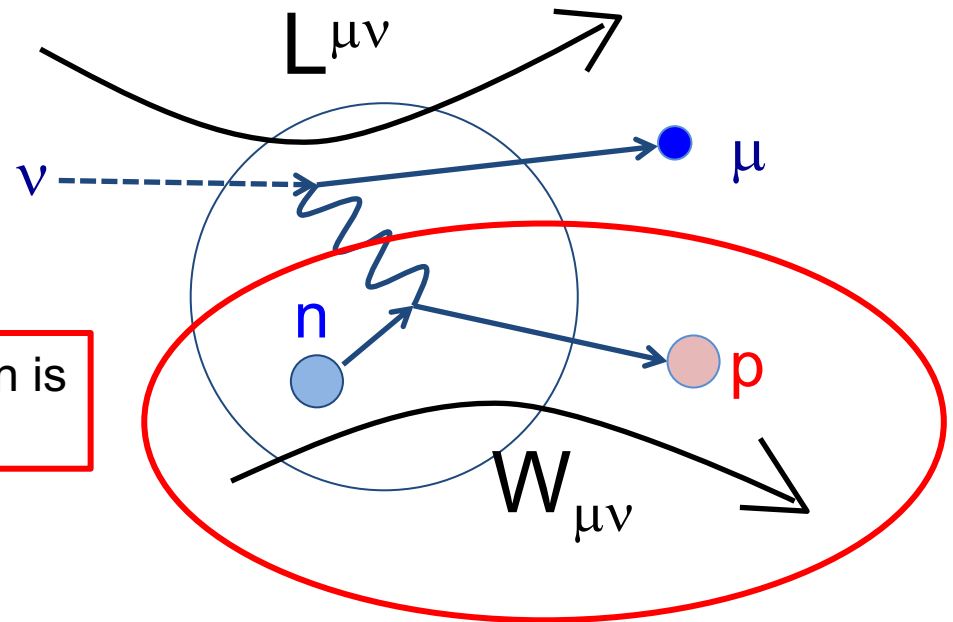

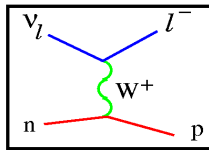

## 2. Charged Current Quasi-Elastic scattering (CCQE)

The simplest and the most abundant interaction around  $\sim 1$  GeV.

$$\nu_{\mu} + n \rightarrow p + \mu^{-} \quad (\nu_{\mu} + X \rightarrow X' + \mu^{-})$$

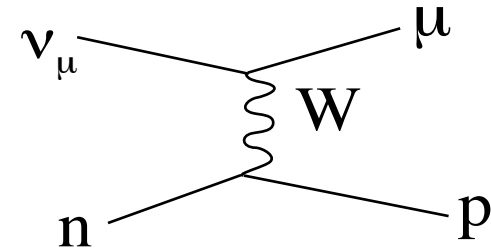

$$d\sigma \sim L_{\mu\nu} T^{\mu\nu}$$

$L_{\mu\nu} \sim J_{\mu} J_{\nu}$ : Lepton tensor

$W_{\mu\nu} = \int f(\vec{k}, \vec{q}, \omega) T_{\mu\nu} dE$ : hadronic tensor

$f(\vec{k}, \vec{q}, \omega)$ : nucleon phase space

$T_{\mu\nu} = T_{\mu\nu}(F_1, F_2, F_A, F_P)$ : nucleon tensor

$F_1, F_2, F_A, F_P$  : form factors

Form factors can be parameterized with **dipole form**

$$F(Q^2) = \frac{g}{\left(1 + \frac{Q^2}{M^2}\right)^2}$$

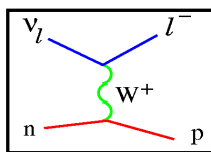

# 2. Form factors

MiniBooNE CCQE cross section  
PRD81(2010)092005

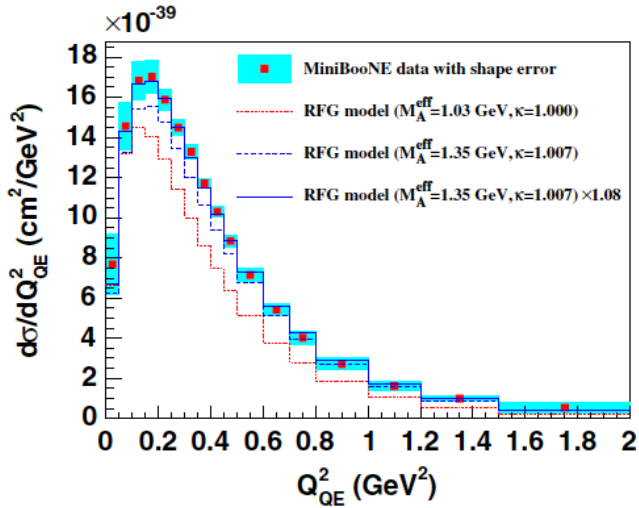

Form factors can be parameterized with **dipole form**

$$F(Q^2) = \frac{g}{\left(1 + \frac{Q^2}{M^2}\right)^2}$$

$\rho(r)$	$ F(q^2) $	Example
pointlike	constant	Electron
exponential	dipole	Proton
gauss	gauss	${}^6\text{Li}$
homogeneous sphere	oscillating	-
sphere with a diffuse surface	oscillating	${}^{40}\text{Ca}$

$r \longrightarrow$                        $|q| \longrightarrow$



## 2. Charged Current Quasi-Elastic scattering (CCQE)

The simplest and the most abundant interaction around ~1 GeV.

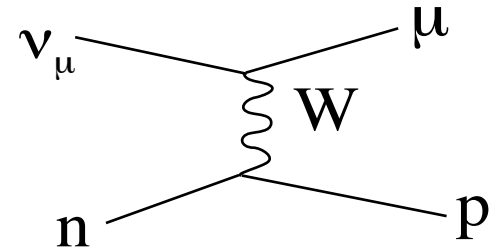
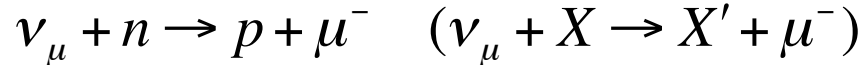

Neutrino energy is reconstructed from the observed lepton kinematics

“QE assumption”

1. assuming neutron at rest
2. assuming interaction is CCQE

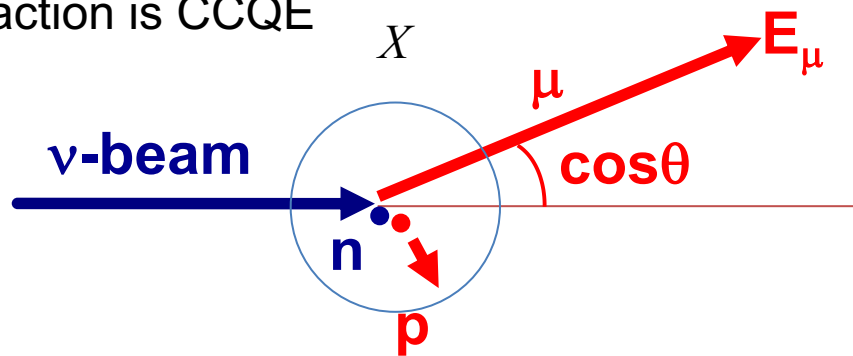

$$E_\nu^{QE} = \frac{ME_\nu - 0.5m_\mu^2}{M - E_\mu + p_\mu \cos\theta}$$

Neutrinos hit nucleons inside of nucleus, and the energy reconstruction is possible only with QE assumption

## 2. Nucleon correlations

### 2-particle 2-hole (2p2h) effect

- Mimic CCQE interaction, significant change cross section (both shape and normalization)
- The biggest topic in nuxsec community (T2K, NOvA, MINERvA, MicroBooNE)

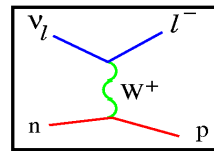

### An explanation of this puzzle

#### Inclusion of the multinucleon emission channel (np-nh)

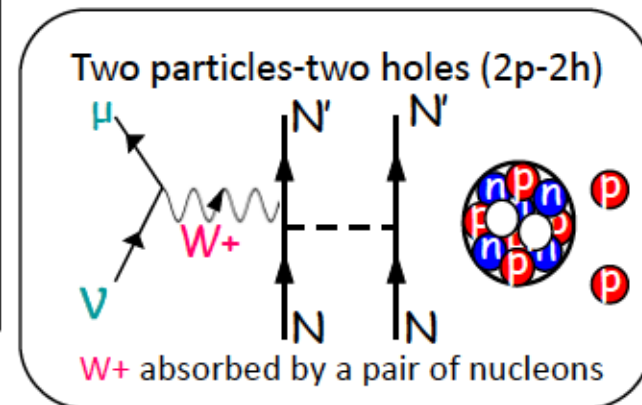
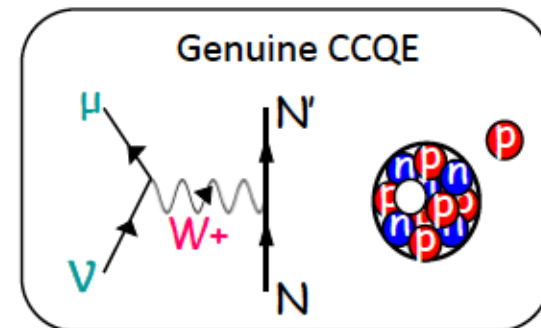
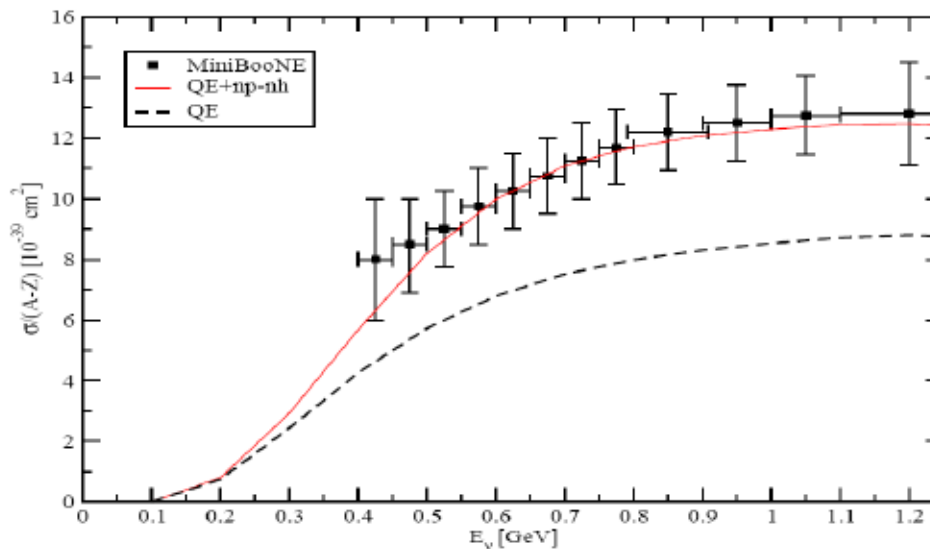

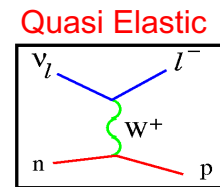

## 2. Nucleon correlations

### 2-particle 2-hole (2p2h) effect

- Mimic CCQE interaction, significant change cross section (both shape and normalization)
- The biggest topic in nuxsec community (T2K, NOvA, MINERvA, MicroBooNE)
- 2p2h models in generators don't describe data well?
- High resolution detector (LArTPC, emulsion, etc) can find what is going on?

NOvA near detector data-MC comparison after fit

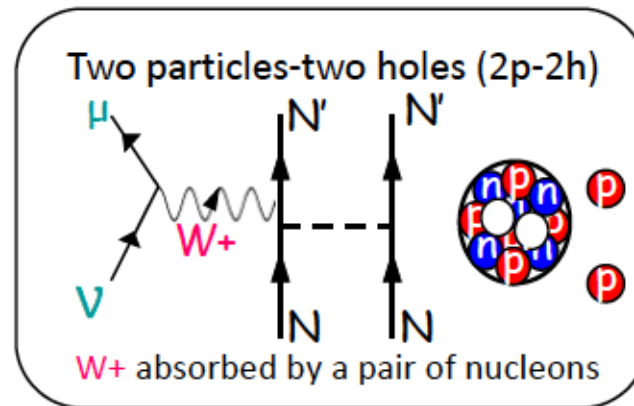
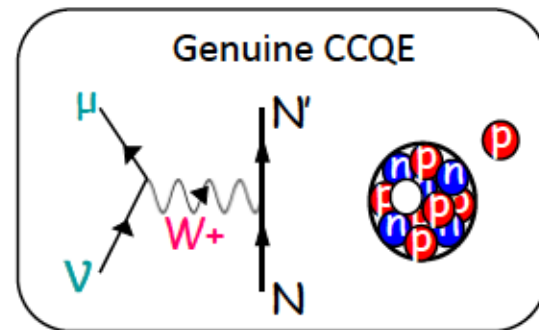
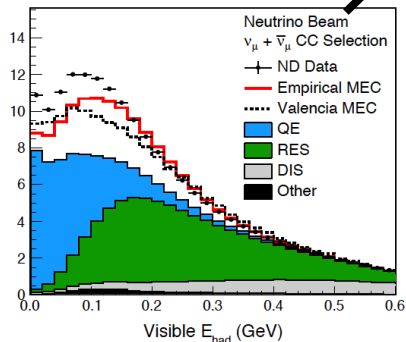
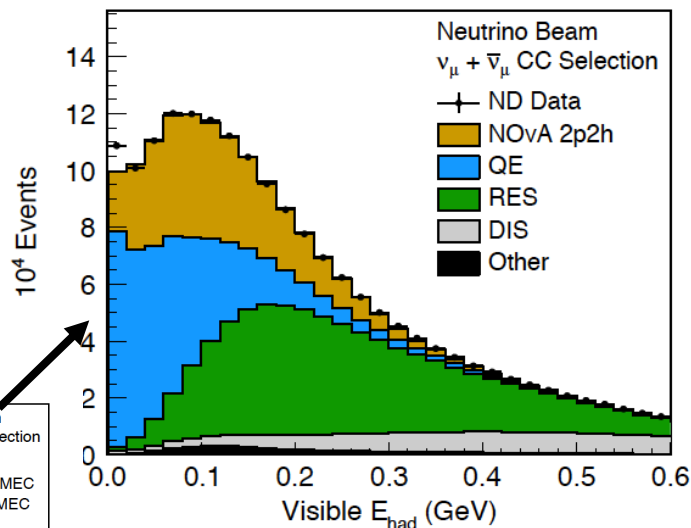

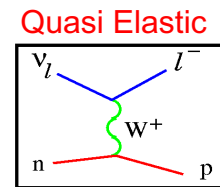

# 2. Fermi motion

## Fermi motion

- Measured energy is smeared from the true energy if you assume nucleon at rest
- High resolution detector can measure all outgoing hadrons
  - initial nucleon momentum can be reconstructed (no Fermi motion smearing)

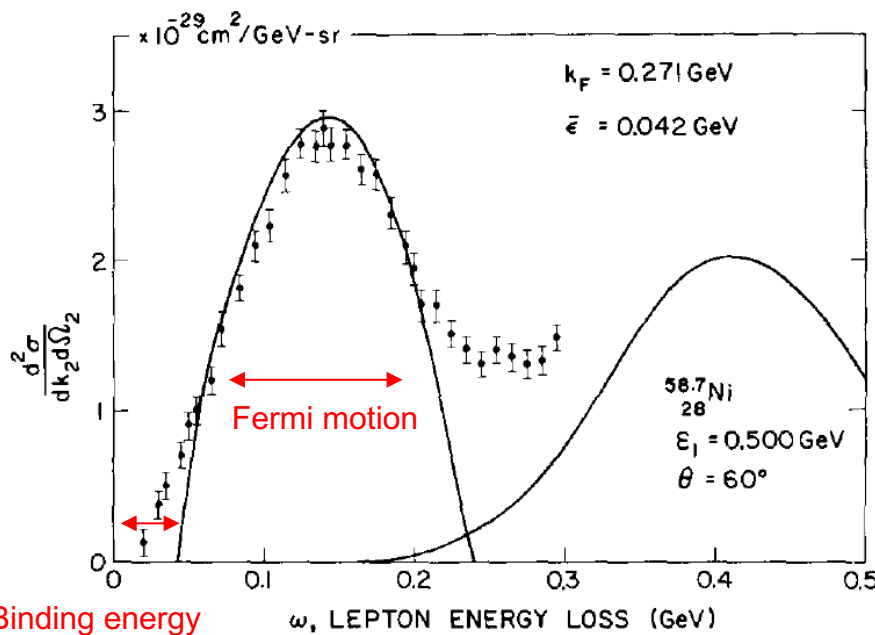

Binding energy

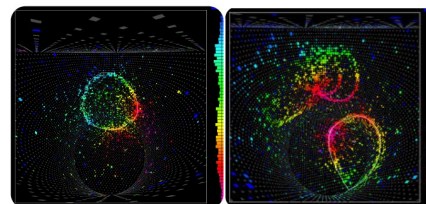

Cherenkov detectors:

Assuming QE interaction

Using lepton only

$$E_{QE} = \frac{2M\epsilon + 2ME_l - m_l^2}{2(M - E_l + |k_l| \cos \theta_l)}$$

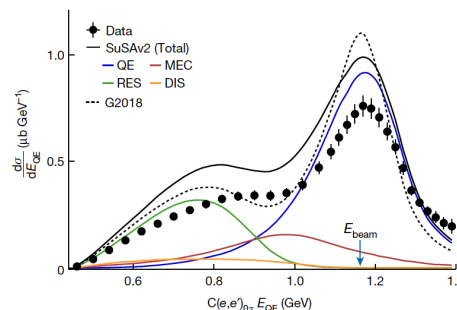

QE formula (HyperK)

tkatori@cern.ch

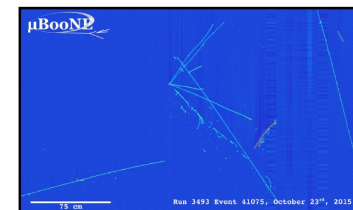

Tracking detectors:

Calorimetric sum

Using All detected particles

$$E_{cal} = E_l + E_p^{kin} + \epsilon$$

[1p0π]

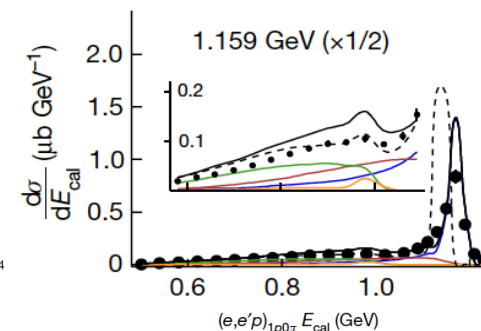

Calorimetric (DUNE)

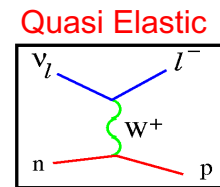

## 2. Pauli blocking

### Pauli blocking

- Low momentum transfer reaction is forbidden.
- data show more suppression than what Pauli blocking can  $\rightarrow$  RPA(?)
- In the global Fermi model, Pauli blocking looks unphysical

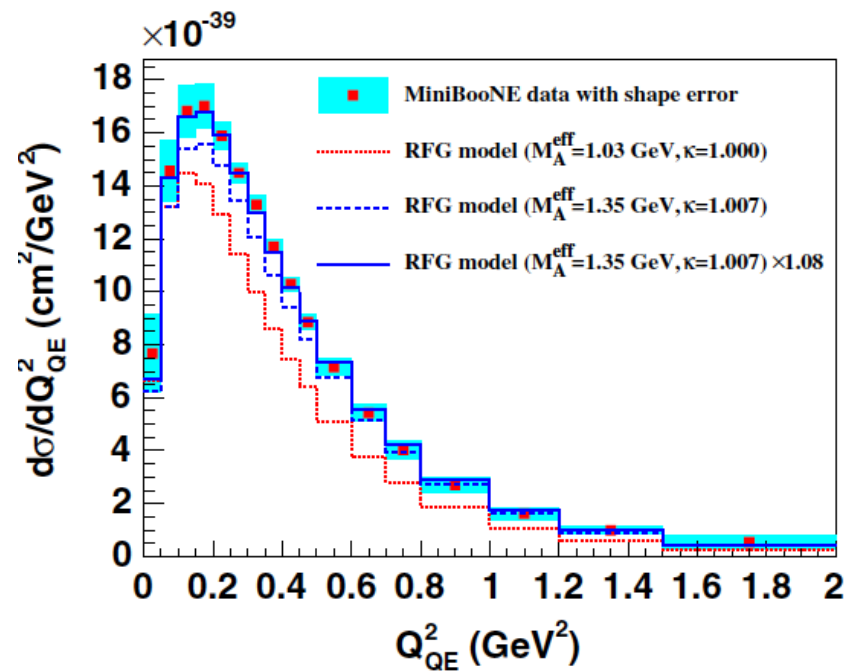
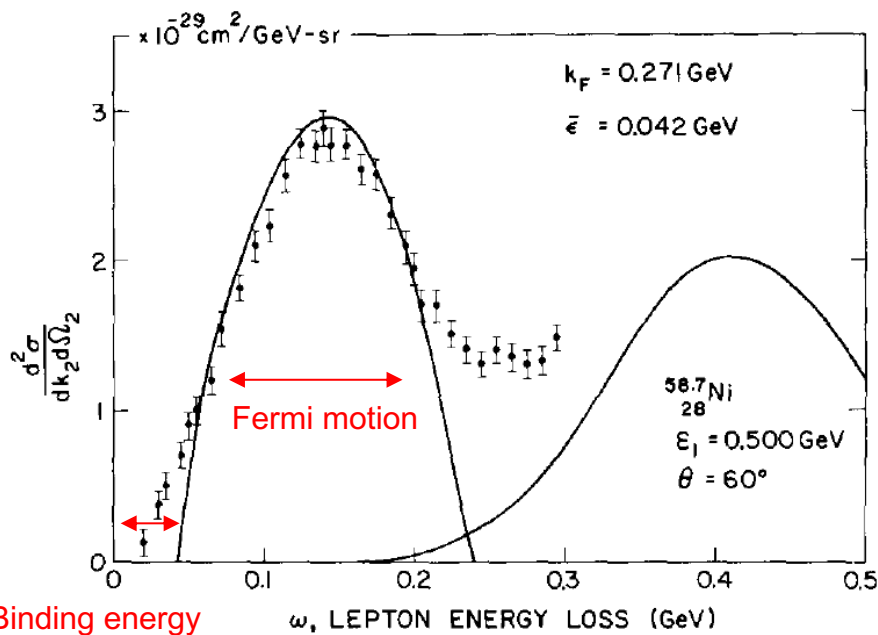

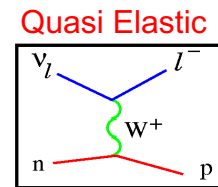

# 2. Nuclear Shell structure and binding energy

Binding energy ~ unobserved energy

- Energy to cost to release 1 nucleon, not constant
- Separation energy + excitation energy + recoil energy
  - Separation energy: energy to release 1 nucleon from the shell (~15 MeV, depends)
  - Excitation energy: energy used to excite leftover target nucleus (~1 MeV)
  - Recoil energy: kinetic energy of recoil target nucleus (~2-3 MeV)

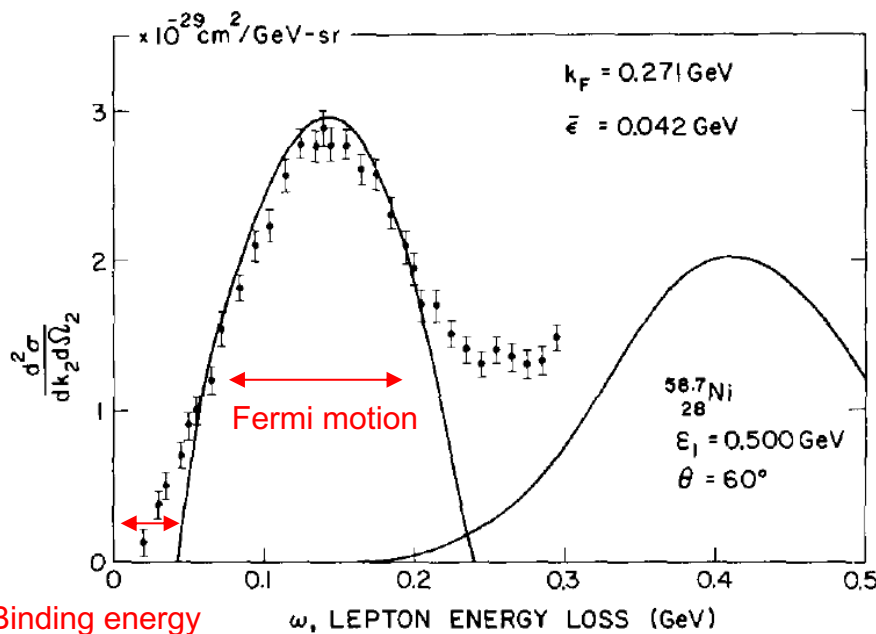

## Electron scattering on proton

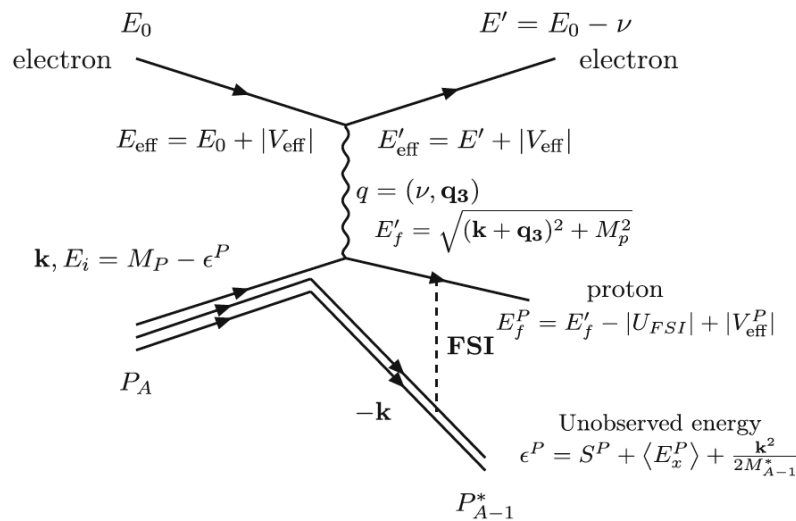

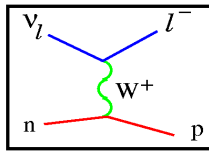

## 2. Final state interaction

### Cascade model

- Elastic scattering: Nucleon elastic scattering, pion elastic scattering
- Inelastic scattering: Nucleon inelastic scattering, pion inelastic scattering
- Charge exchange: Nucleon charge exchange, pion charge exchange
- Absorption: Nucleon absorption, pion absorption

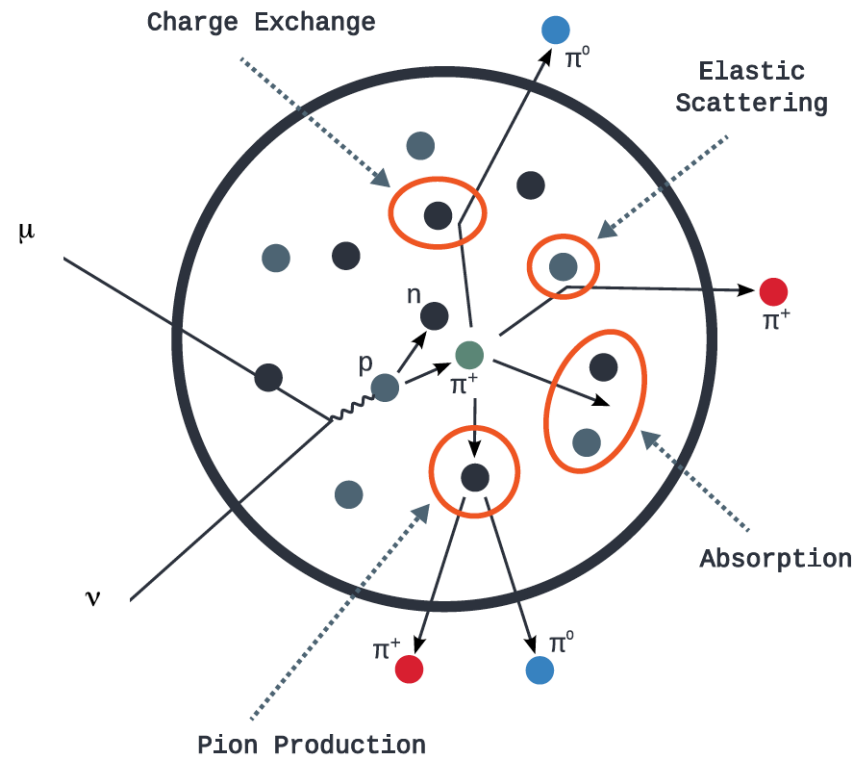

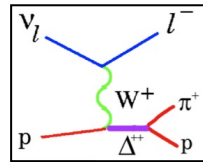

### 3. Neutrino Baryonic resonance data

#### Final state interaction

- Cascade model as a standard of the community
- Advanced models are not available for event-by-event simulation

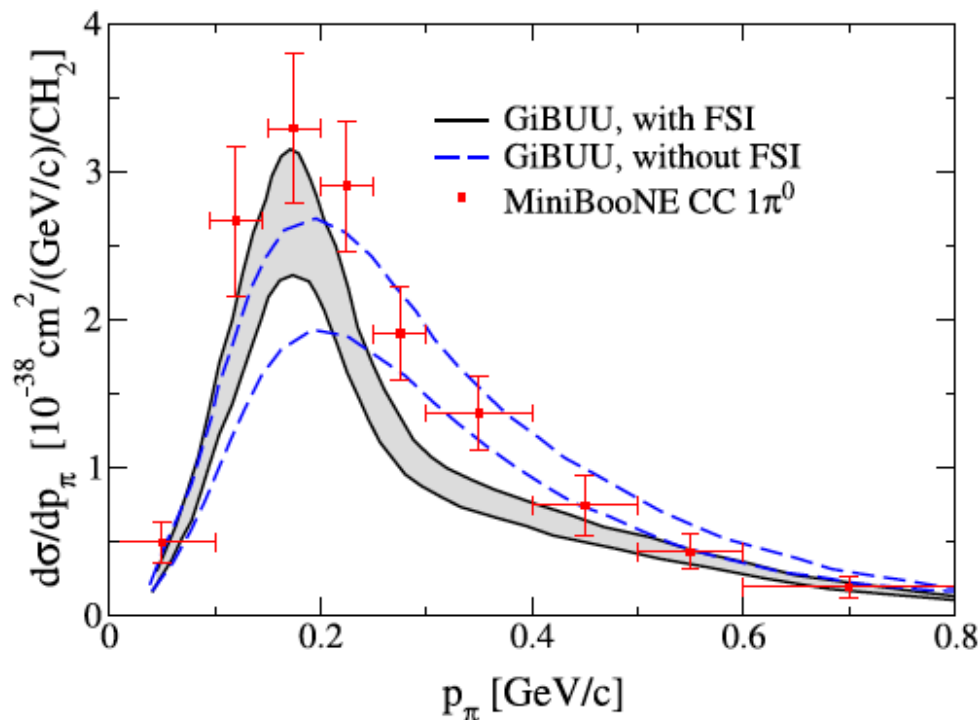
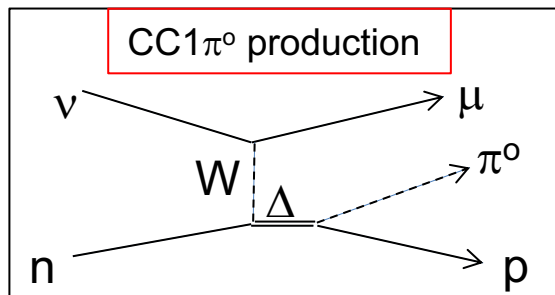

MiniBooNE  $\pi^0$  momentum vs simulation



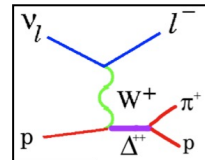

### 3. Neutrino Baryonic resonance data

#### Final state interaction

- Cascade model as a standard of the community
- Advanced models are not available for event-by-event simulation

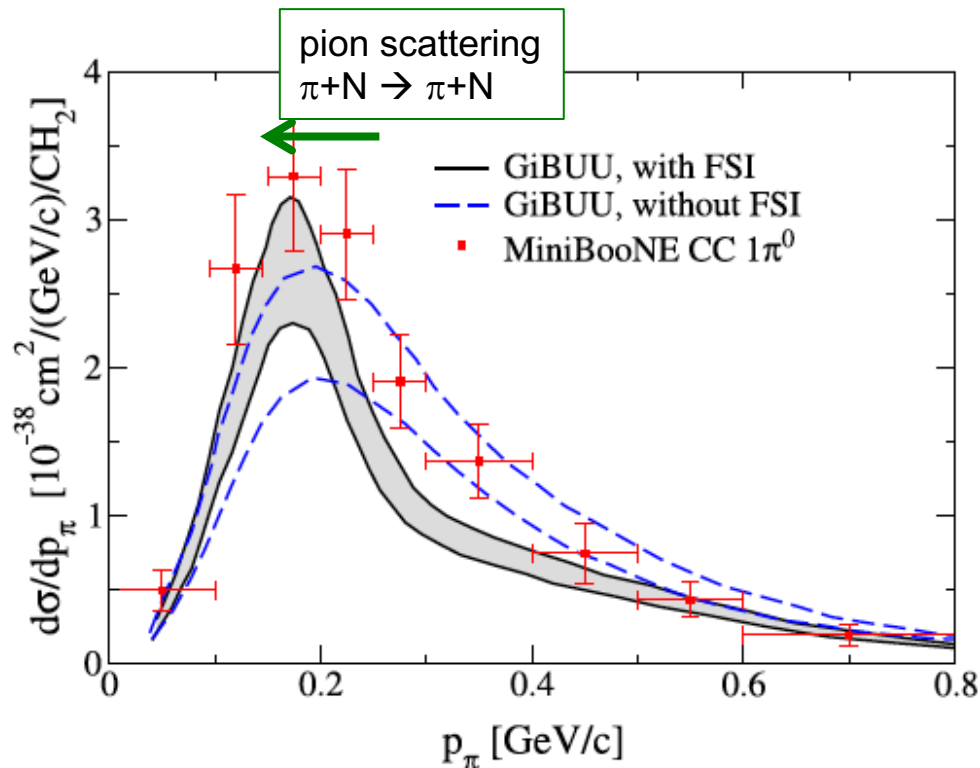
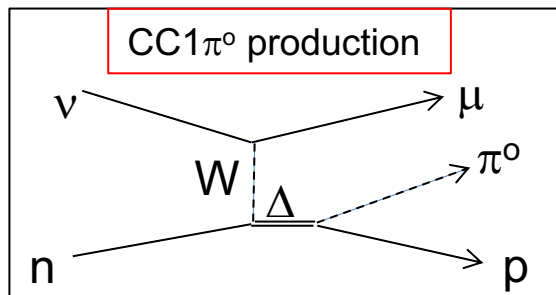

MiniBooNE  $\pi^0$  momentum vs simulation

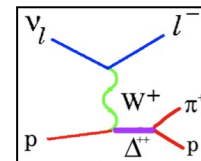

### 3. Neutrino Baryonic resonance data

#### Final state interaction

- Cascade model as a standard of the community
- Advanced models are not available for event-by-event simulation

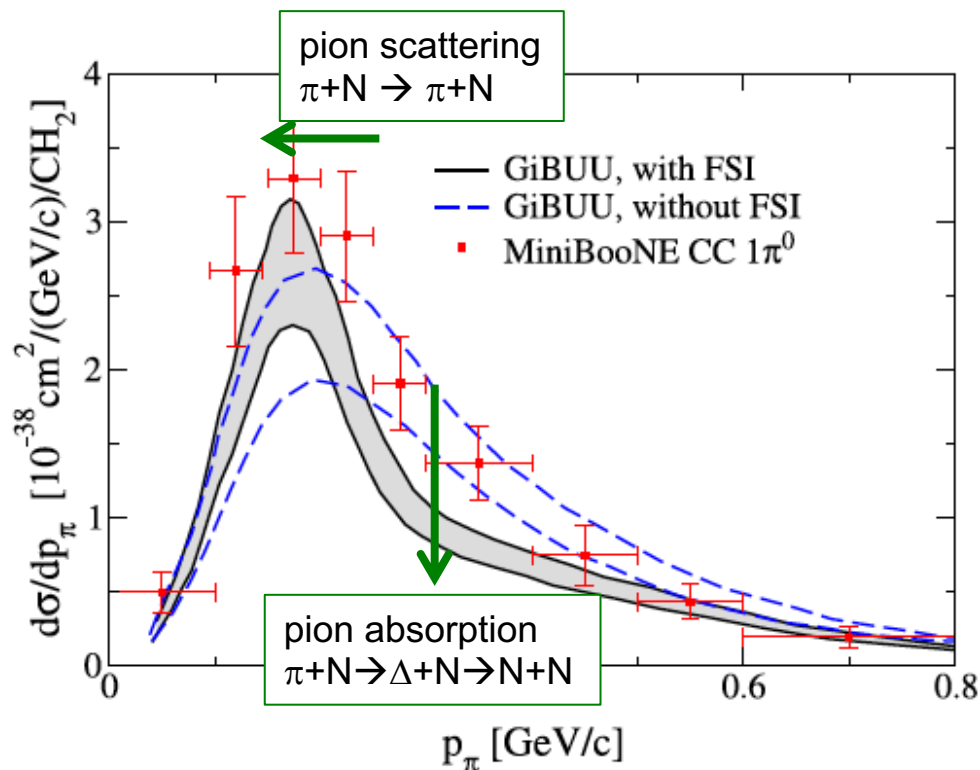
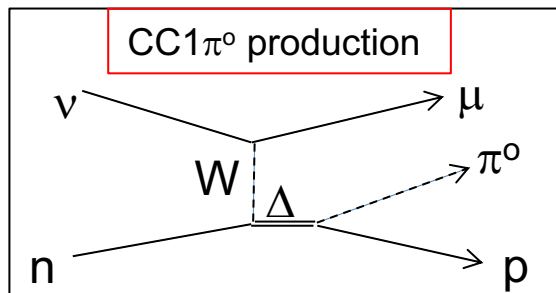

MiniBooNE  $\pi^0$  momentum vs simulation

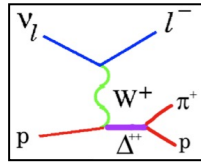

### 3. Neutrino Baryonic resonance data

#### Final state interaction

- Cascade model as a standard of the community
- Advanced models are not available for event-by-event simulation

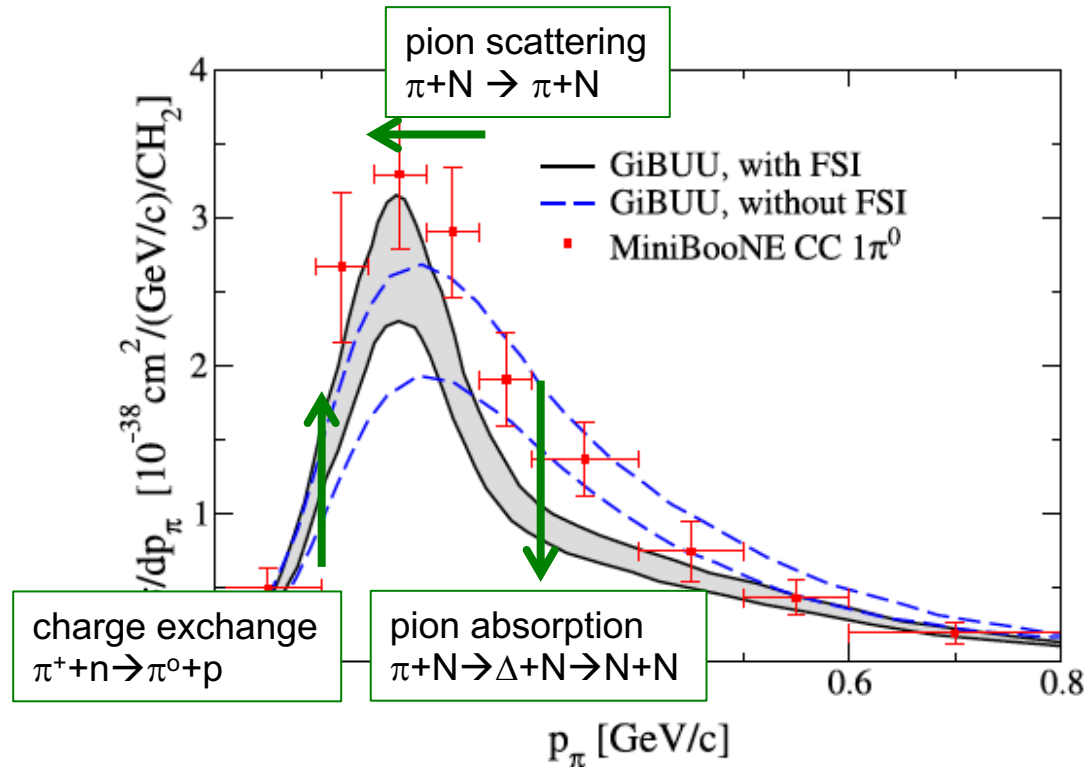
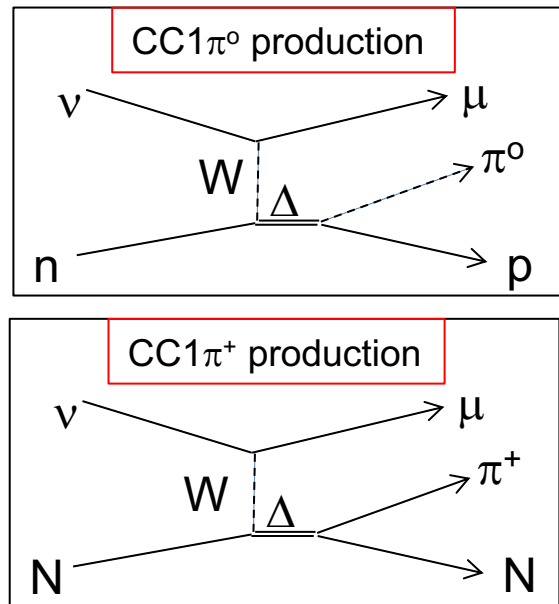

MiniBooNE  $\pi^0$  momentum vs simulation

All neutrino baryonic resonance processes have ~30% errors

### 3. pion production global fit

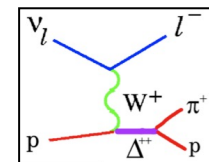

#### MINERvA pion data

- It is extremely difficult to tune pion and/or FSI parameters to fit all pion data
- $\nu_\mu CC\pi^\pm$ , low  $Q^2$  suppression, over-predicted
- $\nu_\mu CC\pi^0$ , strong low  $Q^2$  suppression
- $\bar{\nu}_\mu CC\pi^-$ , no low  $Q^2$  suppression
- $\bar{\nu}_\mu CC\pi^0$ , low  $Q^2$  suppression, under-predicted

The study relies of available knobs in the simulation

It looks the simulation doesn't have good knobs to tune or missing

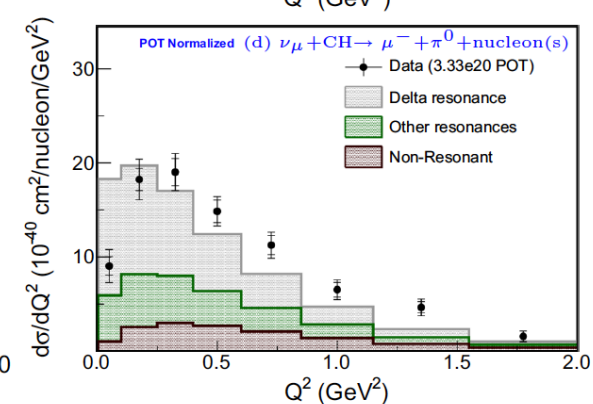
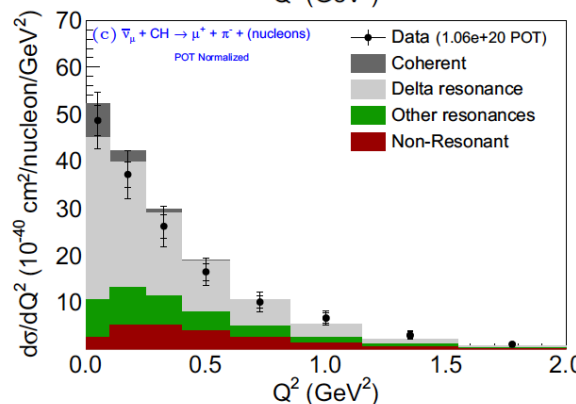
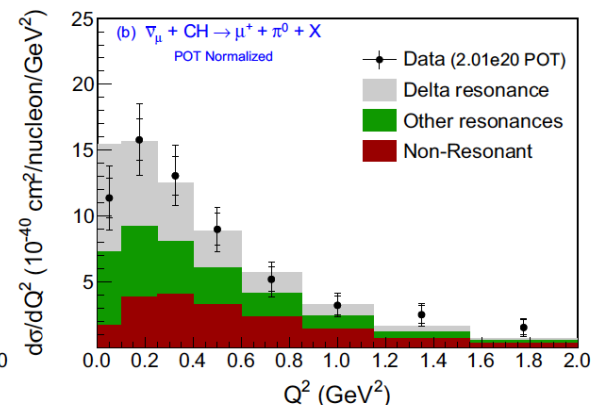
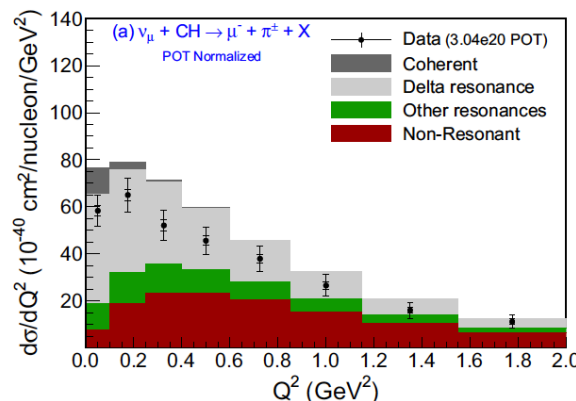

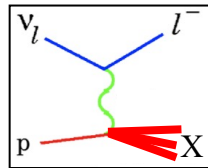

## 4. Shallow- and Deep-Inelastic Scattering (SIS and DIS)

### Cross section

- Higher resonances and hadron dynamics
- Quark-Hadron duality (low  $Q^2$ , low  $W$  DIS)
- Nuclear dependent DIS

Neutrino experiment around 1-10 GeV is not quite DIS yet

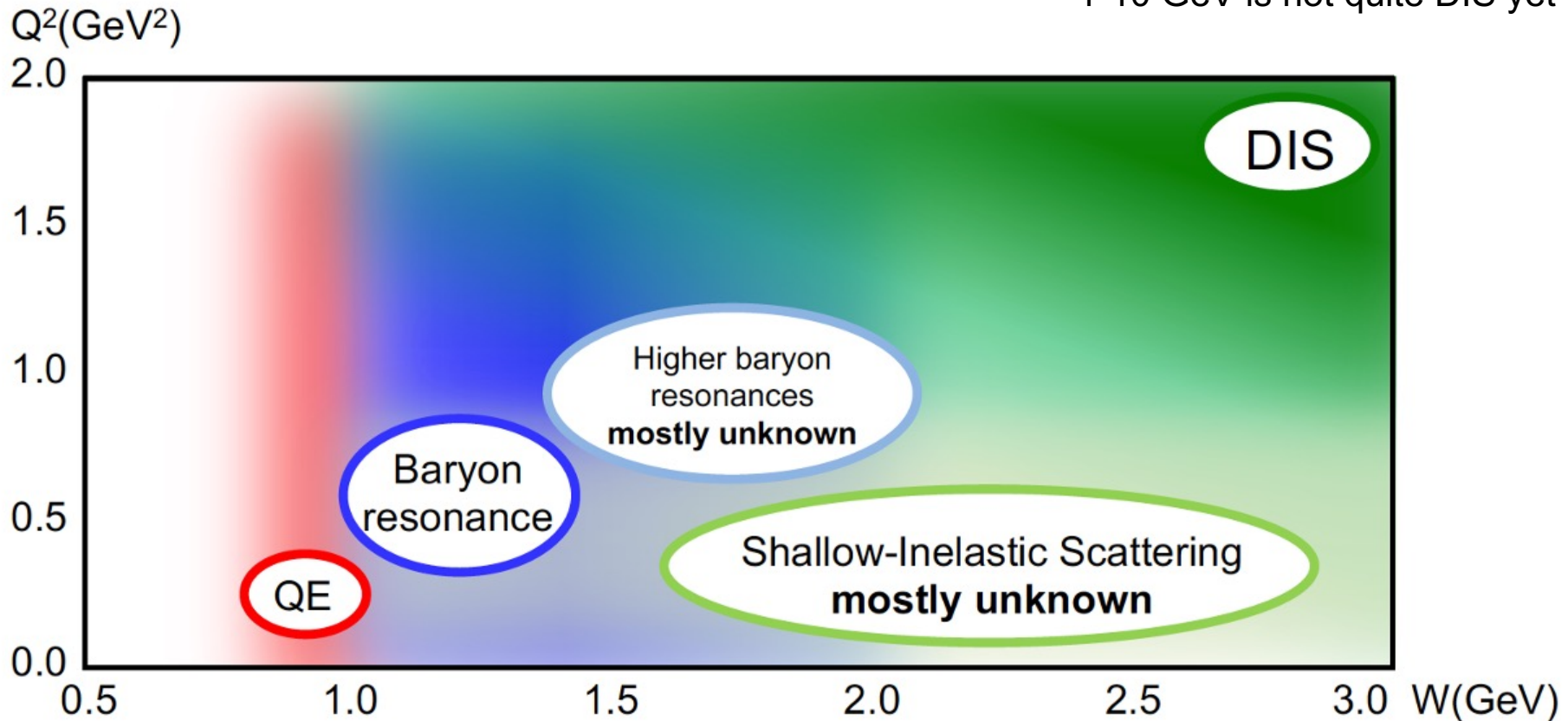

# 4. Higher baryonic resonances

## Cross section

- Higher resonances and hadron dynamics
- Quark-Hadron duality (low  $Q^2$ , low  $W$  DIS)
- Nuclear dependent DIS

## DCC model

- Total amplitude is conserved
- Channels are coupled ( $\pi N$ ,  $\pi\pi N$ , etc)
- 2 pion productions  $\sim 10\%$  at 2 GeV

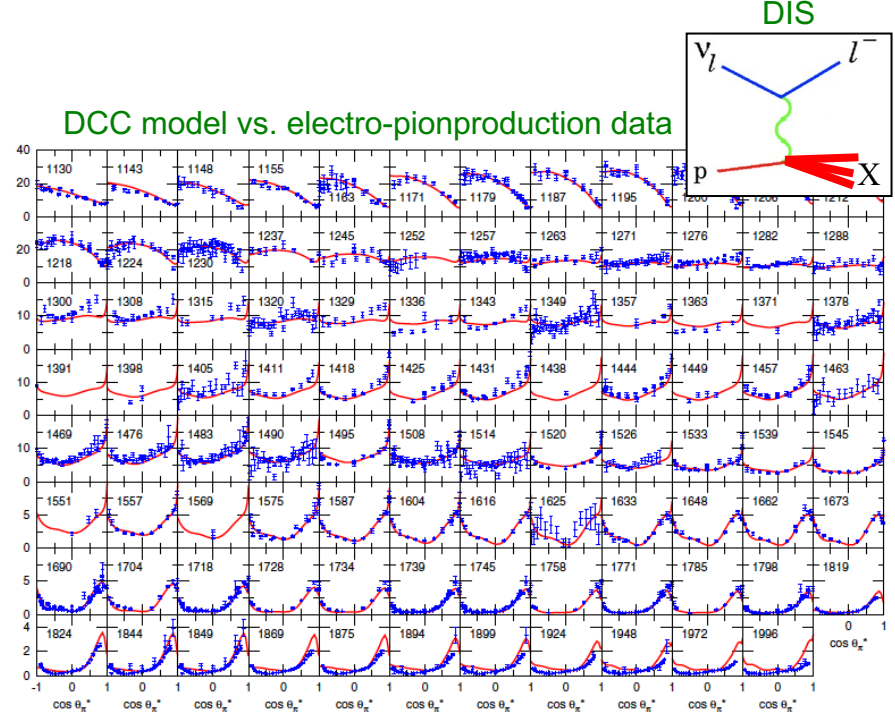
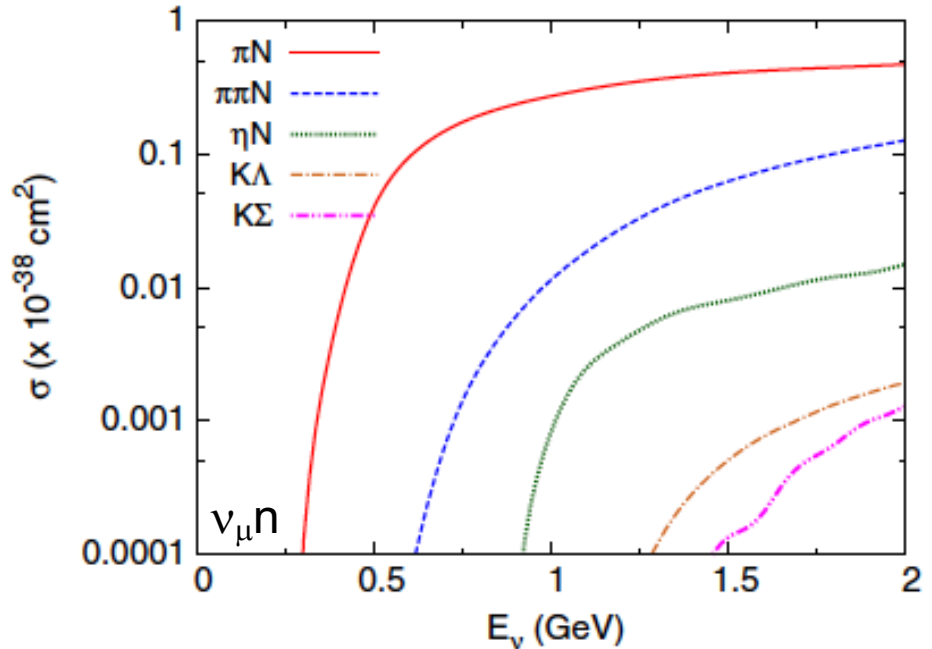
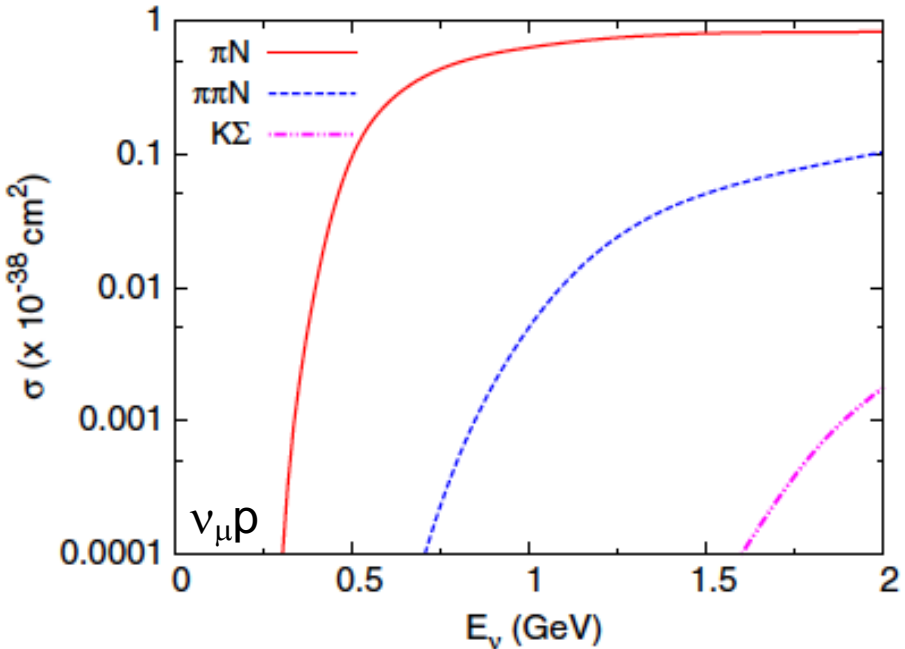
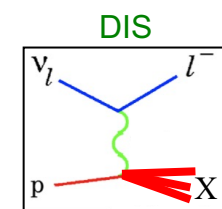

FIG. 8 (color online). Unpolarized differential cross sections,  $d\sigma/d\Omega_*^2$  ( $\mu\text{b/sr}$ ), for  $\gamma n \rightarrow \pi^- p$ . The data are from Refs. [55–78].

# 4. Quark-Hadron duality

Nachtmann variable  $\xi = \frac{2x}{\left(1 + \sqrt{1 + \frac{4x^2 M^2}{Q^2}}\right)}$



## Cross section

- Higher resonances and hadron dynamics
- Quark-Hadron duality (low  $Q^2$ , low  $W$  DIS)
- Nuclear dependent DIS

## GRV98 LO PDF + Bodek-Yang correction

- GRV98 for low  $Q^2$  DIS
- Bodek-Yang correction for QH-duality
- 20 years old, out-of-dated
- not sure how to implement systematic errors

$$\xi \rightarrow \xi_\omega = \frac{2x \left(1 + \frac{M_f^2 + B}{Q^2}\right)}{\left(1 + \sqrt{1 + \frac{4x^2 M^2}{Q^2}}\right) + \frac{2Ax}{Q^2}}$$

$$K_{valence}(Q^2) = \frac{[1 - G_D^2(Q^2)] \cdot \left(\frac{Q^2 + C_{v2}}{Q^2 + C_{v1}}\right)}{Q^2}$$

$$K_{sea}(Q^2) = \frac{1}{Q^2 + C_{s1}}$$

## Proton F2 function GRV98-BY correction vs. data

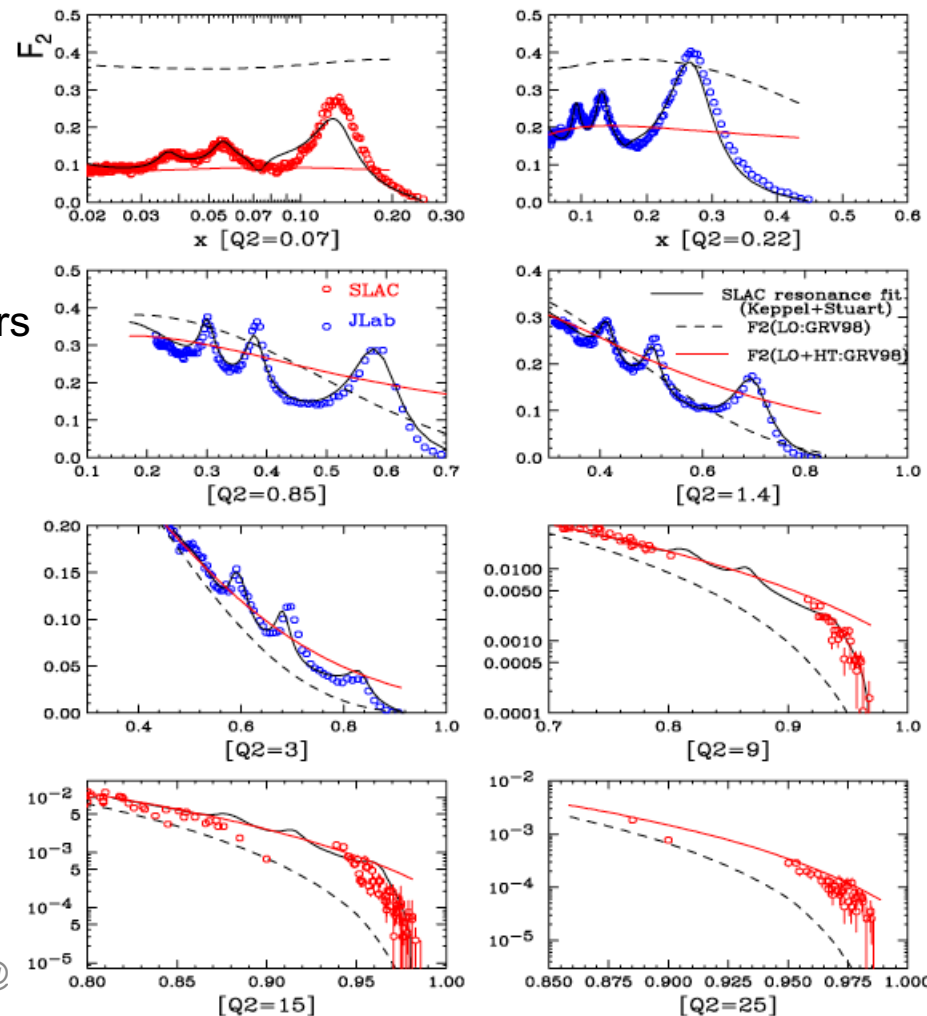

tkatori@

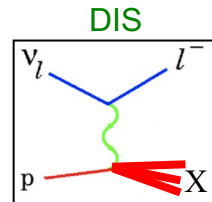

# 4. Nuclear dependent DIS

## Cross section

- Higher resonances and hadron dynamics
- Quark-Hadron duality (low  $Q^2$ , low  $W$  DIS)
- **Nuclear dependent DIS**

## Nuclear PDF

- Shadowing, EMC effect, Fermi motion
- Likely due to nucleon dynamics in nucleus
- Various models describe charged lepton data
- Neutrino data look very different

$e^+$ -Fe nuclear correction factor

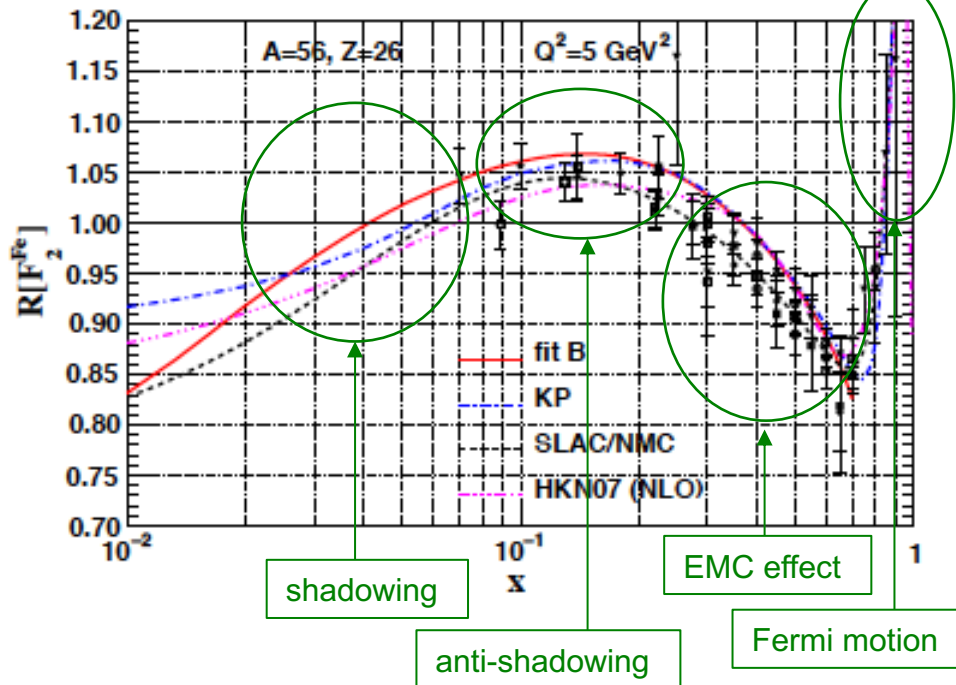

$\nu$ -Fe nuclear correction factor

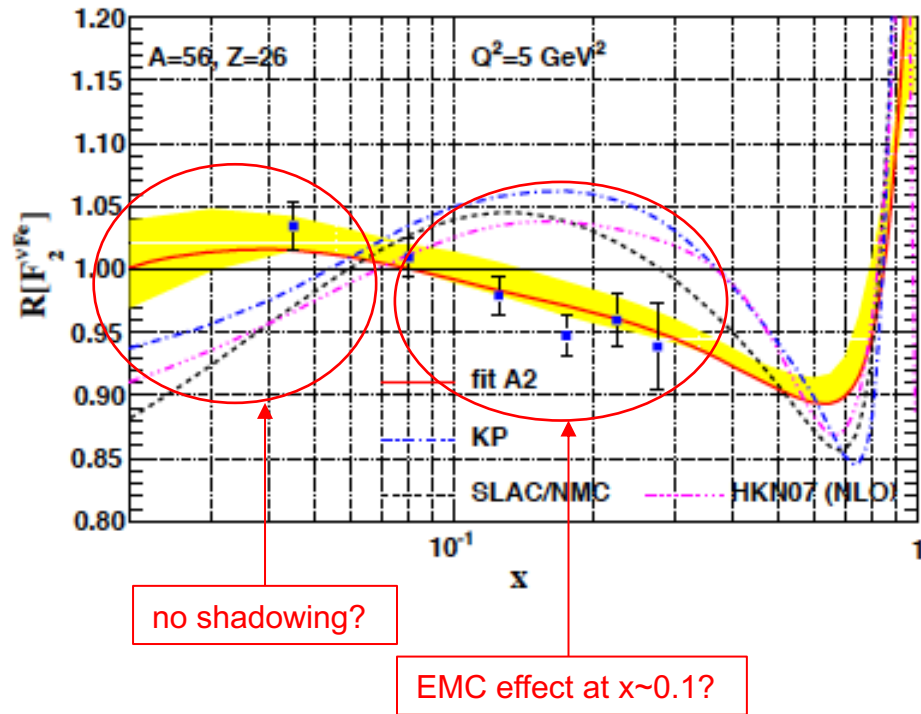



## 4. nuclei are complicated, but do we understand nucleons/

Recent Lattice QCD calculations start to converge axial form factor with longer tail  
 - Similar with large  $M_A^{QE}$  with dipole form factor

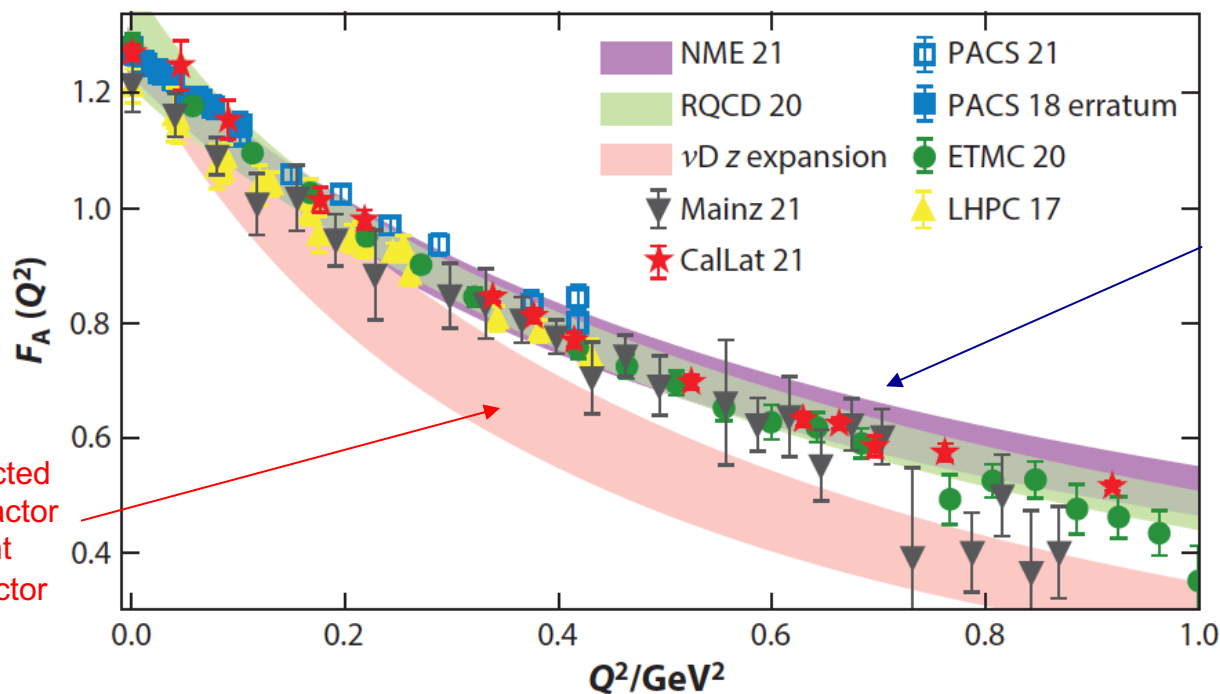

Z-expansion extracted axial vector form factor (which is consistent with dipole form factor with  $M_A^{QE} \sim 1 \text{ GeV}$ )

Lattice QCD calculations by different groups (which is consistent with dipole form factor with  $M_A^{QE} \sim 1.3 \text{ GeV}$ )

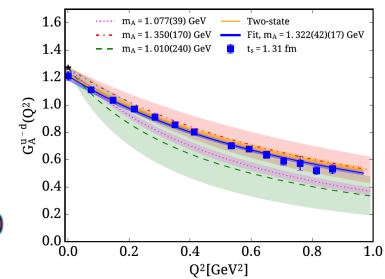

## Conclusion

$\nu$ -N scattering : important reactions for long baseline neutrino oscillation experiment  
(T2K, NOvA, DUNE, Hyper-Kamiokande, etc)

CCQE: charged-current quasi-elastic, around 1 GeV

RES: baryonic resonance, around 2 GeV

DIS: deep inelastic scattering, 3 GeV to higher

Nuclear physics sucks

- Fermi motion: nucleon motion smears kinematic reconstruction
- Pauli blocking: It limits low momentum transfer reaction
- Nuclear shell structure: separation energy (missing energy) for different nucleons
- Final state interaction: RES looks like CCQE, DIS looks like RES, etc
- Nucleon correlation: Physics between  $\nu$ -N and  $\nu$ -A interaction
- Quark-Hadron duality: Physics between  $\nu$ -q and  $\nu$ -N interaction
- Nuclear dependent PDF: Physics between  $\nu$ -q and  $\nu$ -A interaction
- Not only nuclei, but also we don't understand how to model nucleons

Currently, ~30% error is acceptable for many processes

# Backup

# References (books)

Quarks and Leptons (Halzen and Martin)

- show many calculations
- solutions for all exercises

Weak interactions of Leptons and Quarks (Commins and Bucksbaum)

- show details of weak interaction calculations
- too many typos

Physics of Neutrinos (Fukugita and Yanagida)

- very intense
- from solar neutrinos to SUSY

Neutrino astrophysics (Bahcall)

- good book to read

Foundation of Nuclear and Particle Physics (2017)

- Authors: Donnelly, Formaggio, Holstein, Milner, Surrow
- buy if your PhD thesis topic is about neutrino cross section measurements in T2K, NOvA, SBN, etc

The Physics of Neutrino interactions (2020)

- Authors: Sajjad Athar, Singh
- The newest book in this kind (970 pages!)

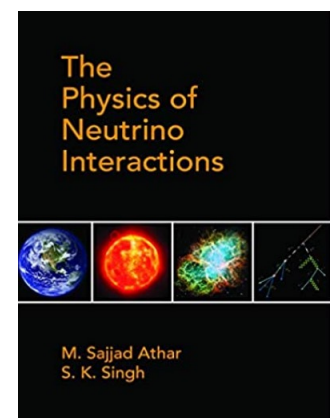
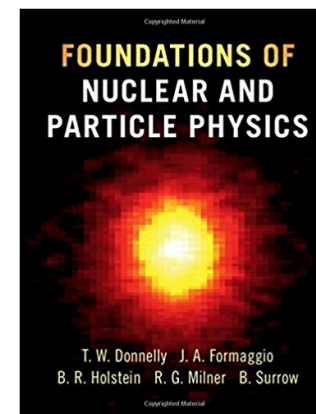
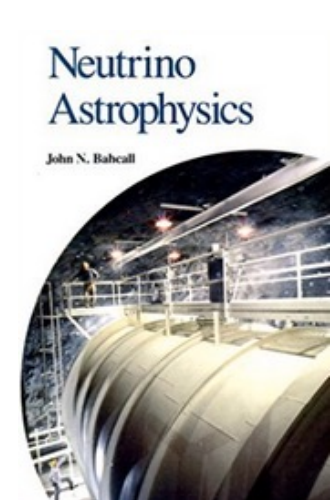
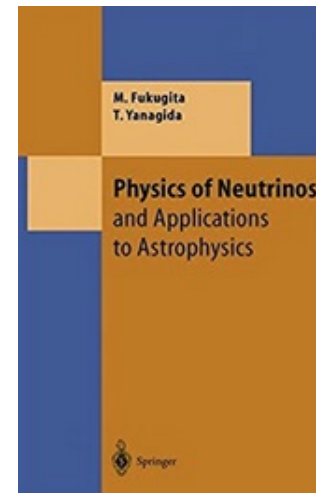
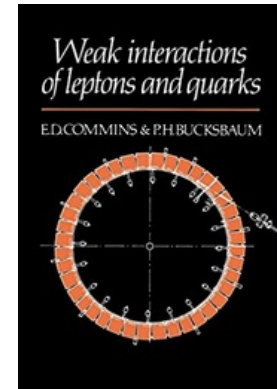
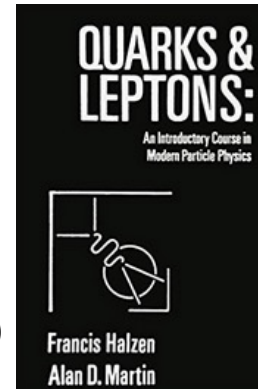

# References (papers)

“From eV to EeV: Neutrino cross sections across energy scales”

- Authors: Formaggio and Zeller (MicroBooNE spokesperson)
- Rev.Mod.Phys.84(2012)1307, <https://arxiv.org/abs/1305.7513>
- very good summary of neutrino cross sections

“Neutrino-Nucleus Cross Sections for Oscillation Experiments”

- Authors: Katori (me) and Martini (Martini model)
- J.Phys. G45 (2018) no.1, 013001, <https://arxiv.org/abs/1611.07770>
- A review both theoretical and experimental views

“NuSTEC White Paper: Status and challenges of neutrino–nucleus scattering”

- NuSTEC (Neutrino Scattering Theory-Experiment Collaboration)
- Prog.Part.Nucl.Phys. 100 (2018) 1-68, <https://arxiv.org/abs/1706.03621>
- Cover all open issues in the community

“NuSTEC News”

- <http://nustec.fnal.gov/>
- subscribe mailing list, “like” facebook page, use #nuxsec



The image shows a screenshot of the NuSTEC website. At the top, there is a navigation bar with the Fermilab logo and the text "50 Years of Discovery". The navigation menu includes links for Home, Contact, Phone Book, Fermilab at Work, Jobs, We are 50, About, Science, Newsroom, Come visit us, and Resources for. Below the navigation bar, there is a search bar and a main content area. The main content area features a large banner for "NuSTEC: Neutrino Scattering Theory Experiment Collaboration". Below the banner, there are two promotional banners: "NuINT 2017" (25-30 JUNE 2017, THE FIELDS INSTITUTE, UNIVERSITY OF TORONTO) and "NuSTEC School 2017" (7-15 November 2017, Fermilab, USA). The website also includes a sidebar with links for Home, NuSTEC school, NuSTEC News, NuInt conference series, Workshops, conferences, schools, Database, and NuSTEC News. At the bottom of the sidebar, there are social media icons for Facebook, Twitter, and YouTube, along with the website URL "nustec.fnal.gov/school2017".