

Liquid Argon TPC Detector R&D in USA

1. Introduction
2. US LArTPC programs
3. LAr photon detection R&D
4. Challenge of LArTPC technology
5. Conclusion

MicroBooNE PMT test stand
(photo by Reidar Hahn, Fermilab)

Tepei Katori

Queen Mary University of London

RAL PPD seminar, Rutherford Appleton Lab, Oxford, Feb. 19 2014

1. Introduction
2. US LArTPC programs
3. LAr photon detection R&D
4. Challenge of LArTPC technology
5. Conclusion

1. Liquid Argon Time Projection Chamber (LArTPC)

The principle of LArTPC
- 3D track reconstruction

Bo Yu (BNL)

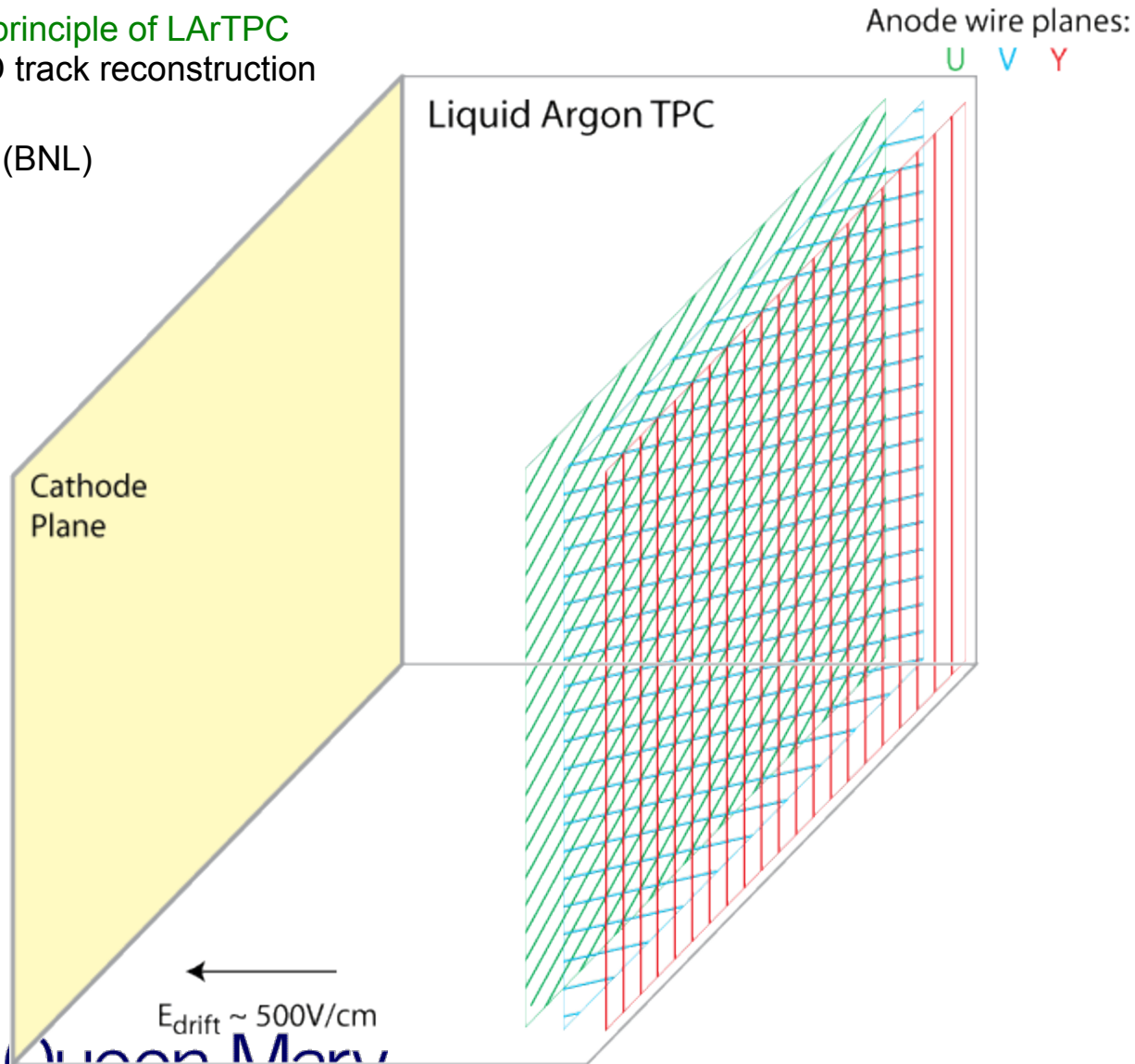

1. Liquid Argon Time Projection Chamber (LArTPC)

The principle of LArTPC
- 3D track reconstruction

Bo Yu (BNL)

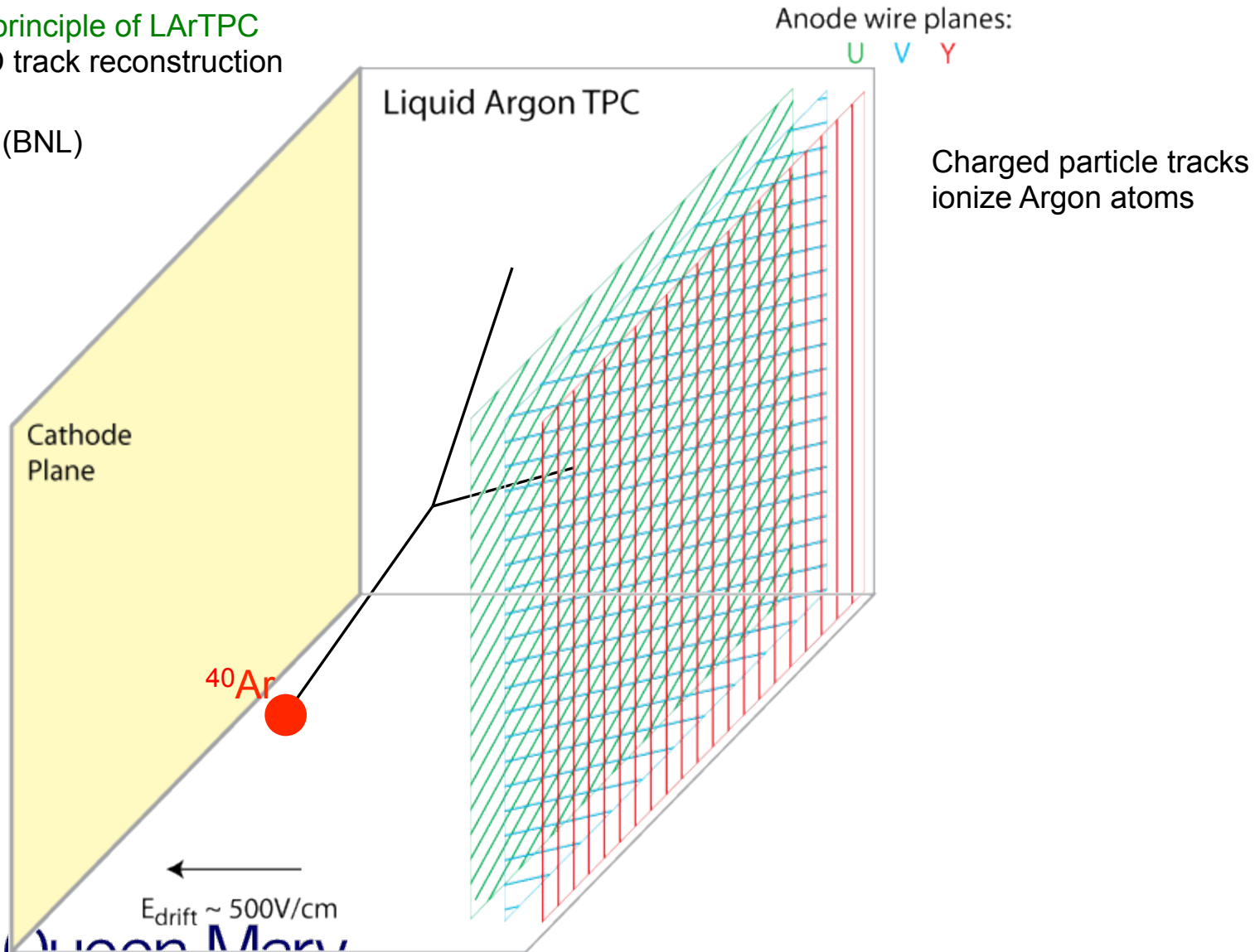

1. Liquid Argon Time Projection Chamber (LArTPC)

The principle of LArTPC
- 3D track reconstruction

Bo Yu (BNL)

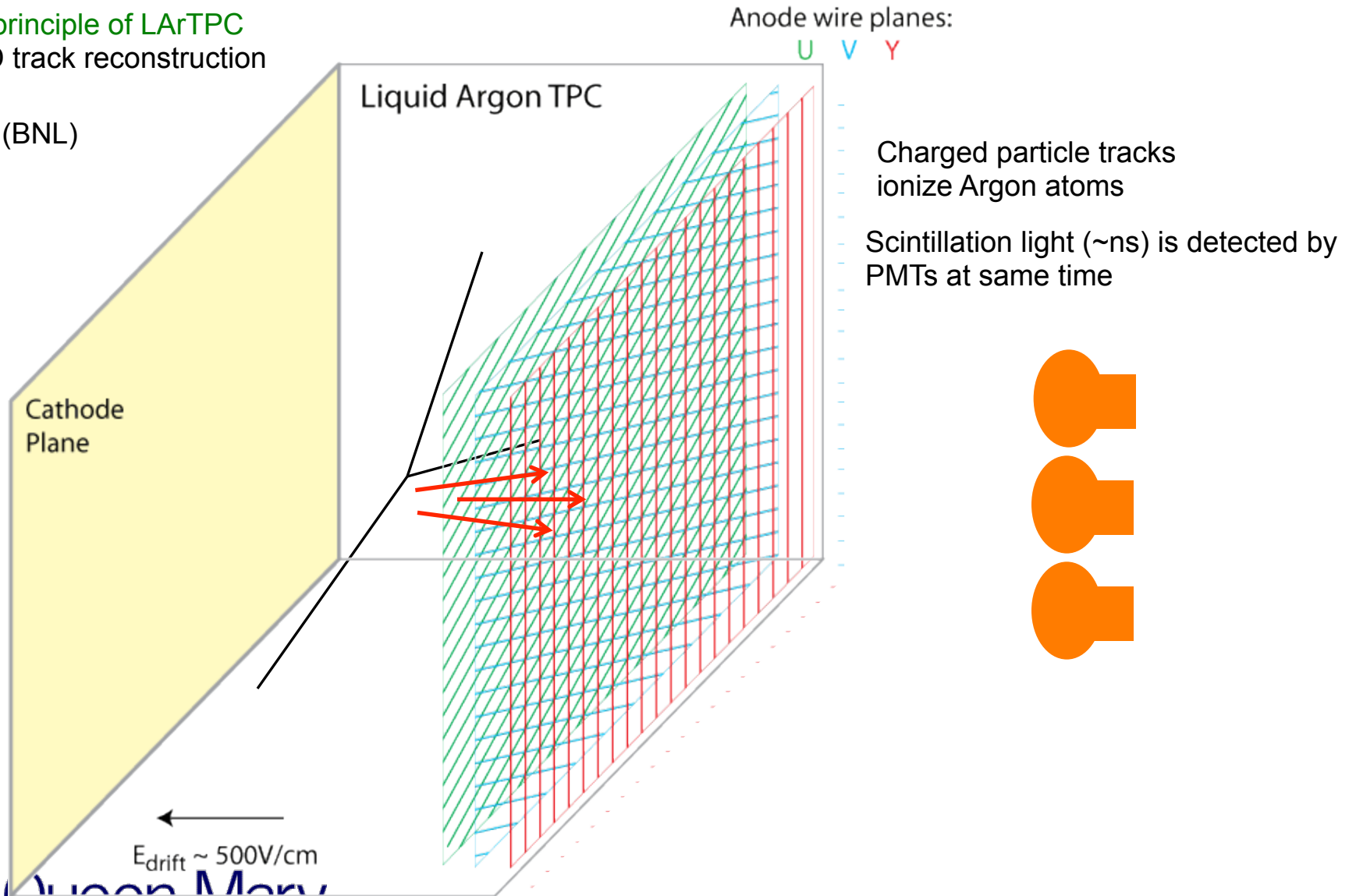

1. Liquid Argon Time Projection Chamber (LArTPC)

The principle of LArTPC
- 3D track reconstruction

Bo Yu (BNL)

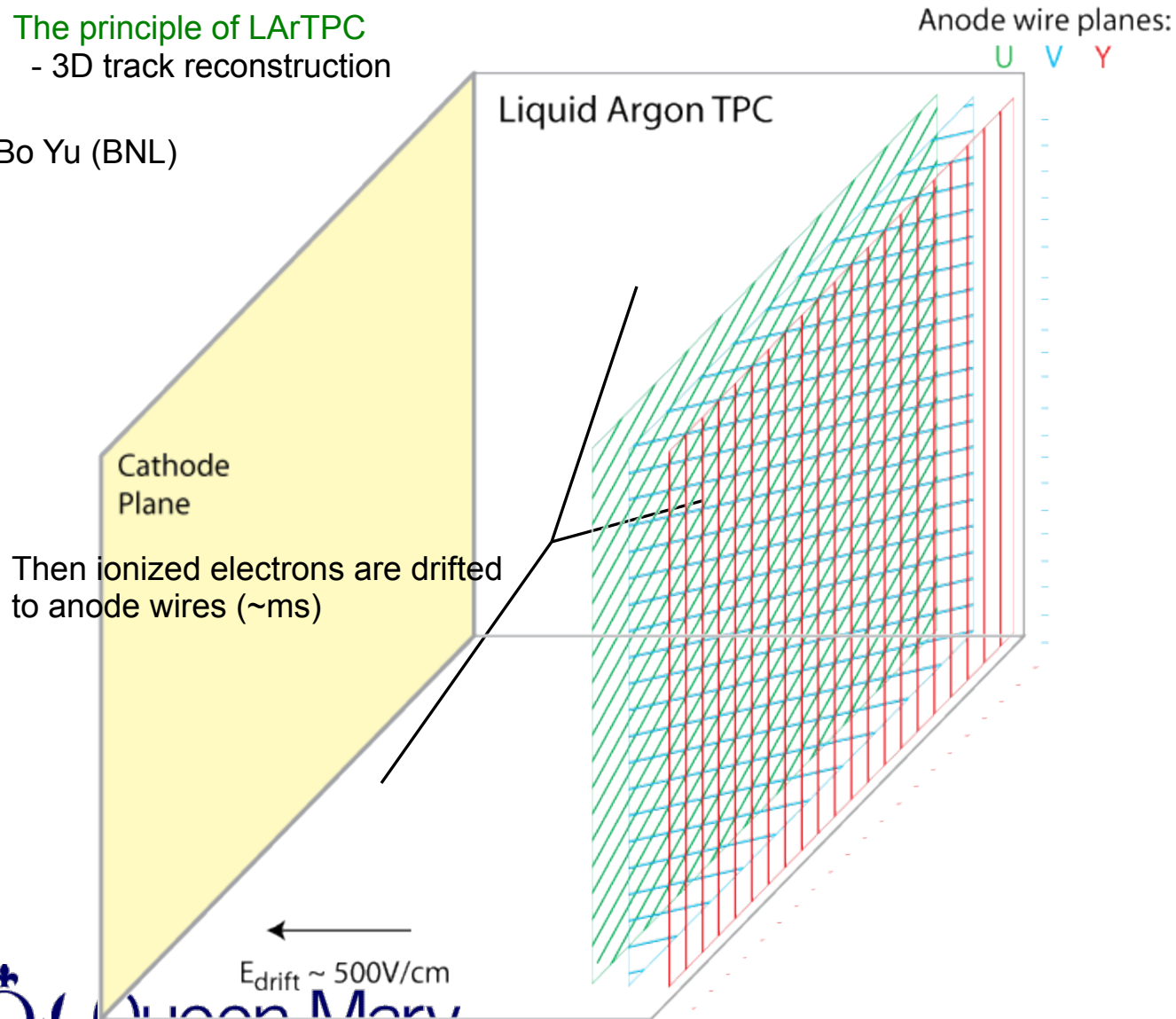

1. Liquid Argon Time Projection Chamber (LArTPC)

The principle of LArTPC
- 3D track reconstruction

Bo Yu (BNL)

Liquid Argon TPC

Anode wire planes:

U V Y

Cathode Plane

Then ionized electrons are drifted to anode wires (~ms)

Electrons near the wires are collected first, and electrons far from the wires are collected last, so drift coordinate information is converted to electron drift time (time is projected)

$E_{\text{drift}} \sim 500\text{V/cm}$

Teppei Katori

02/19/14

Charge Signal Formation

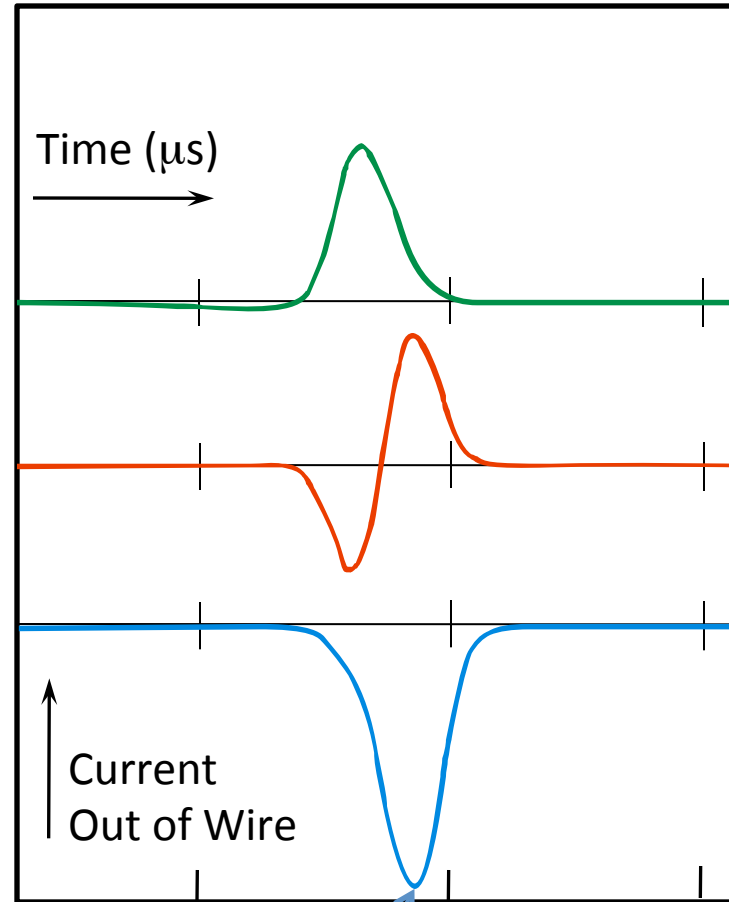
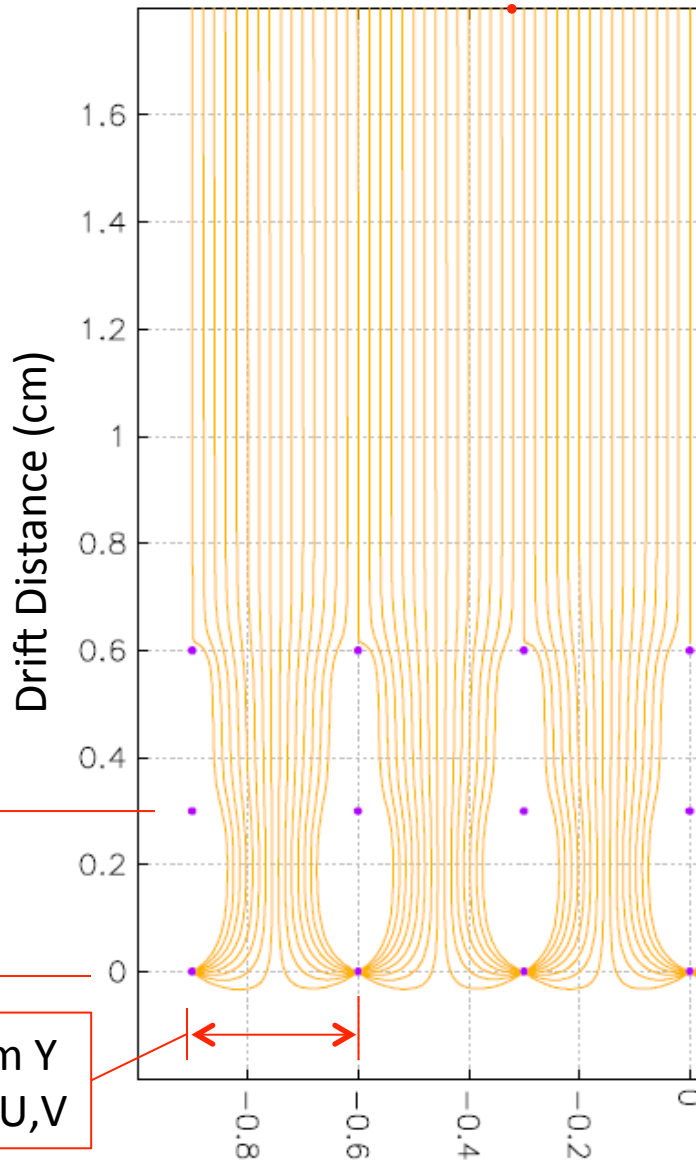

U Induction
(small, bipolar)

V Induction
(small, bipolar)

Y Collection
(large, unipolar)

ArgoNeuT
1 MIP peak \sim 26 ADC counts
Noise rms \sim 1 ADC count

1. Introduction
2. USA LArTPC programs
3. LAr photon detection R&D
4. Challenge of LArTPC technology
5. Conclusion

2. USA LArTPC programs

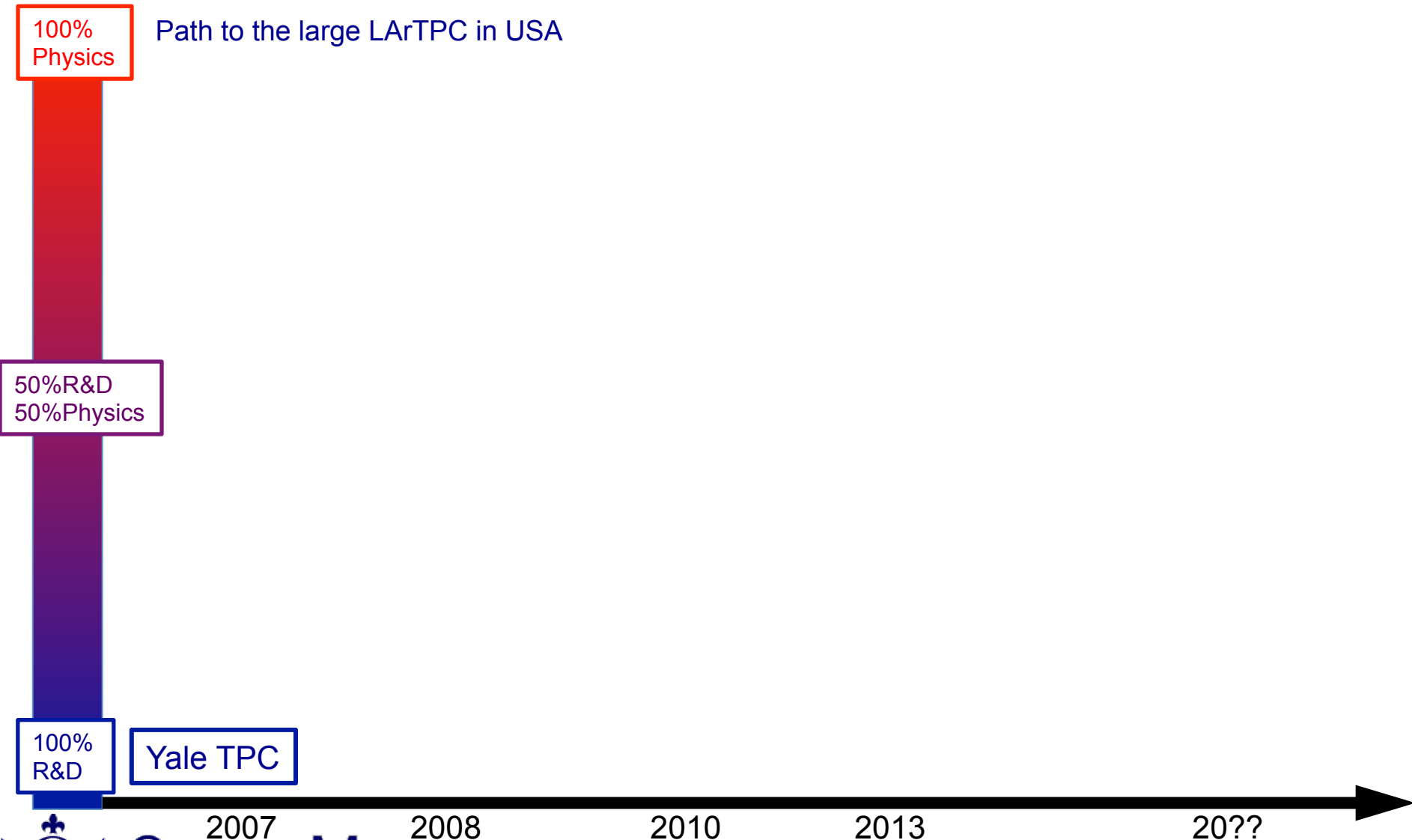

2. Yale TPC

TPC vessel sitting in LAr bath

- 2 plane reeading, 50 wires with 5 mm pitch
- LAr filter in line (ppm→few tenth of ppb)
- not cryostat, but TPC vessel is sitting in LAr bath

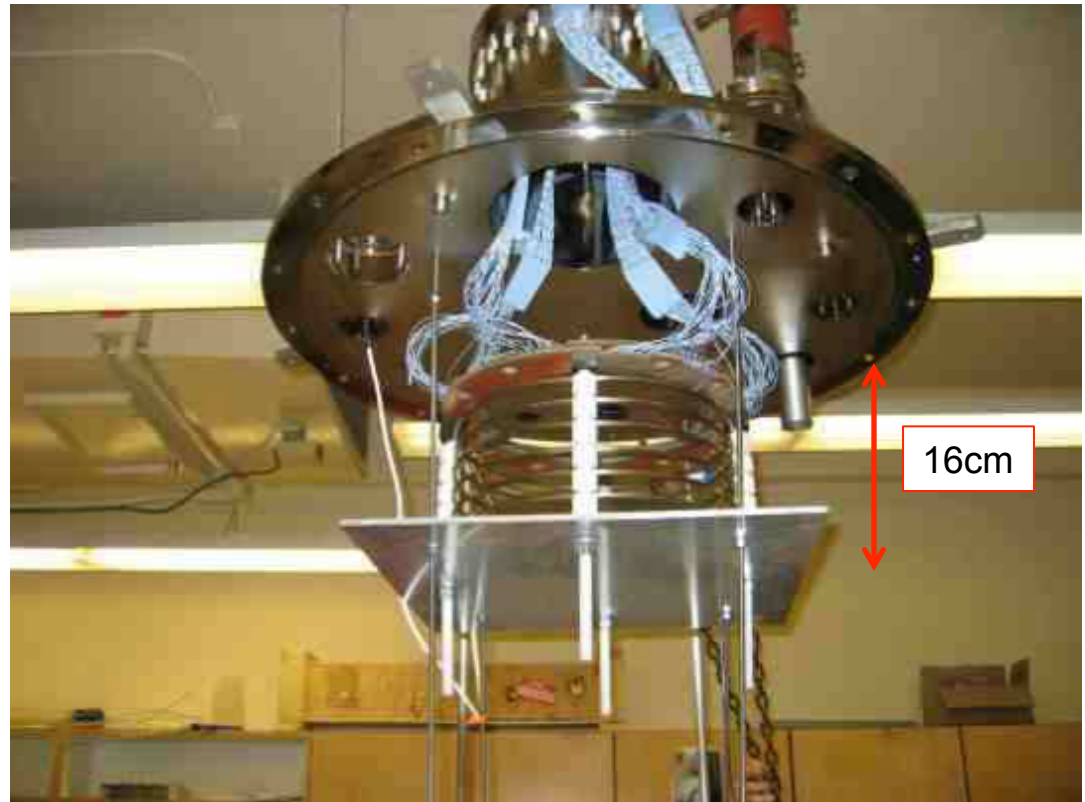

2. Yale TPC

TPC vessel sitting in LAr bath

- 2 plane reeading, 50 wires with 5 mm pitch
- LAr filter in line (ppm \rightarrow few tenth of ppb)
- not cryostat, but TPC vessel is sitting in LAr bath

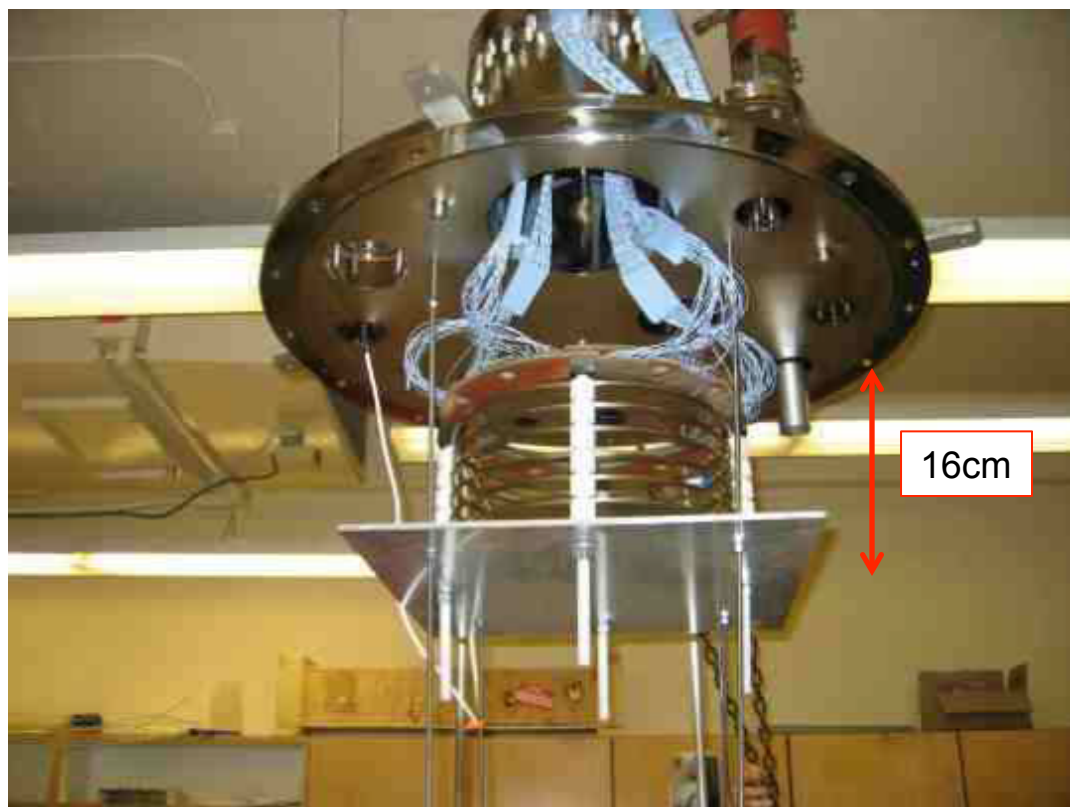
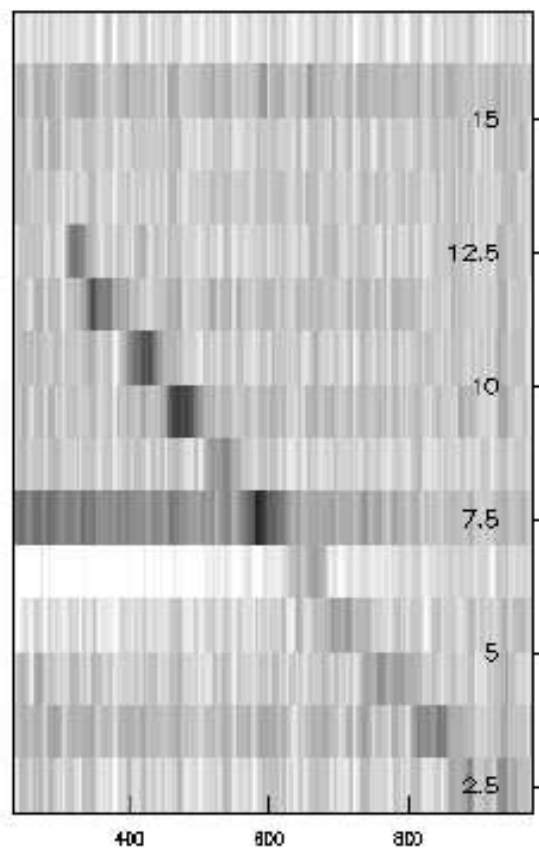

Figure 5. Muon crossing the TPC (collection view).

1. USA LArTPC programs

100%
Physics

Path to the large LArTPC in USA

50%R&D
50%Physics

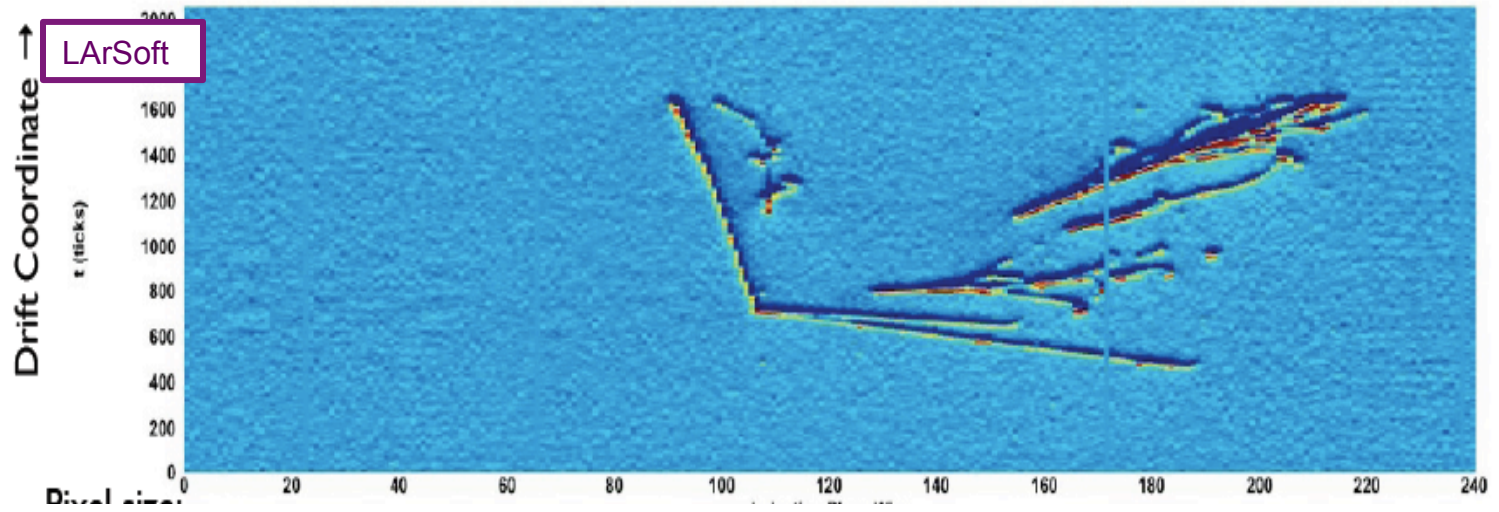

100%
R&D

Yale TPC

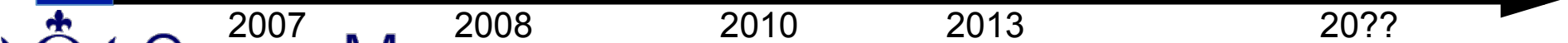

2007

2008

2010

2013

20??

2. LArSoft

Reconstruction is hard

- Biggest effort on software development
- Cambridge join MicroBooNE/LBNE with PANDORA
- Not reliable shower reconstruction yet (all study is done with true info, or imitated detector effect)

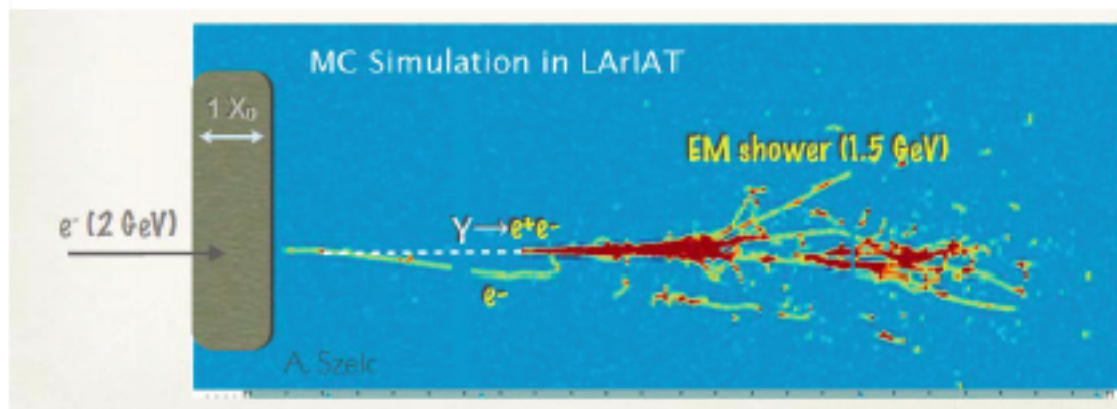
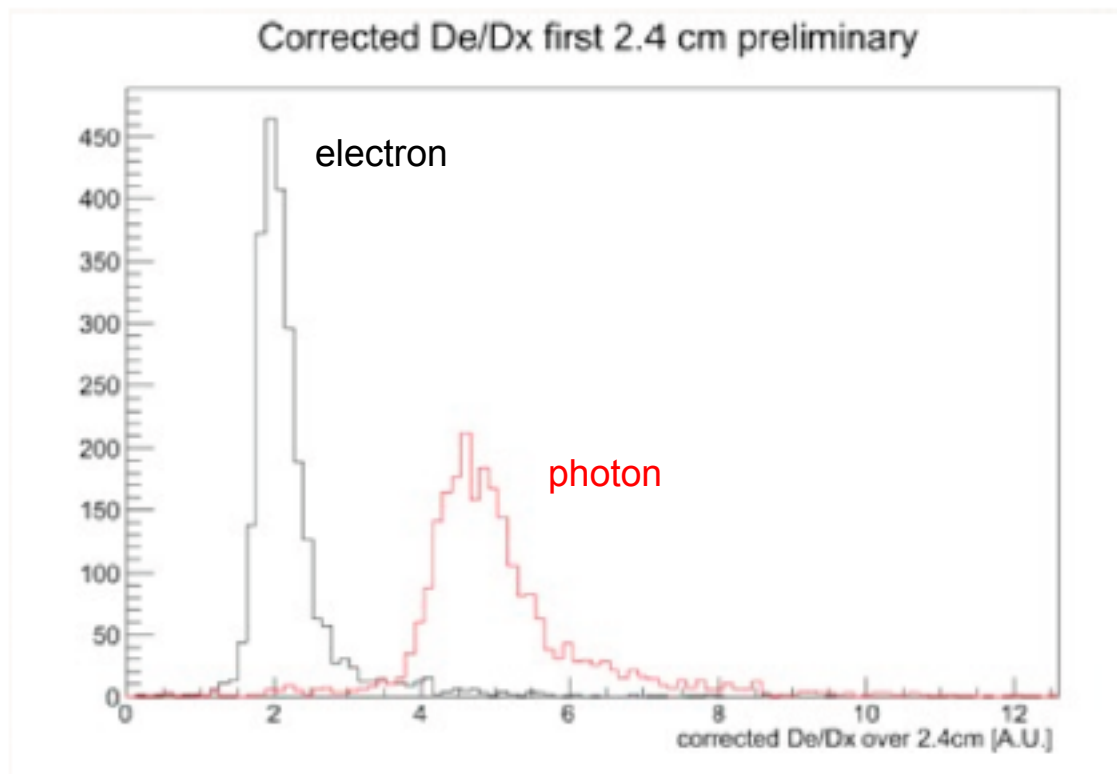

1. USA LArTPC programs

100%
Physics

Path to the large LArTPC in USA

50%R&D
50%Physics

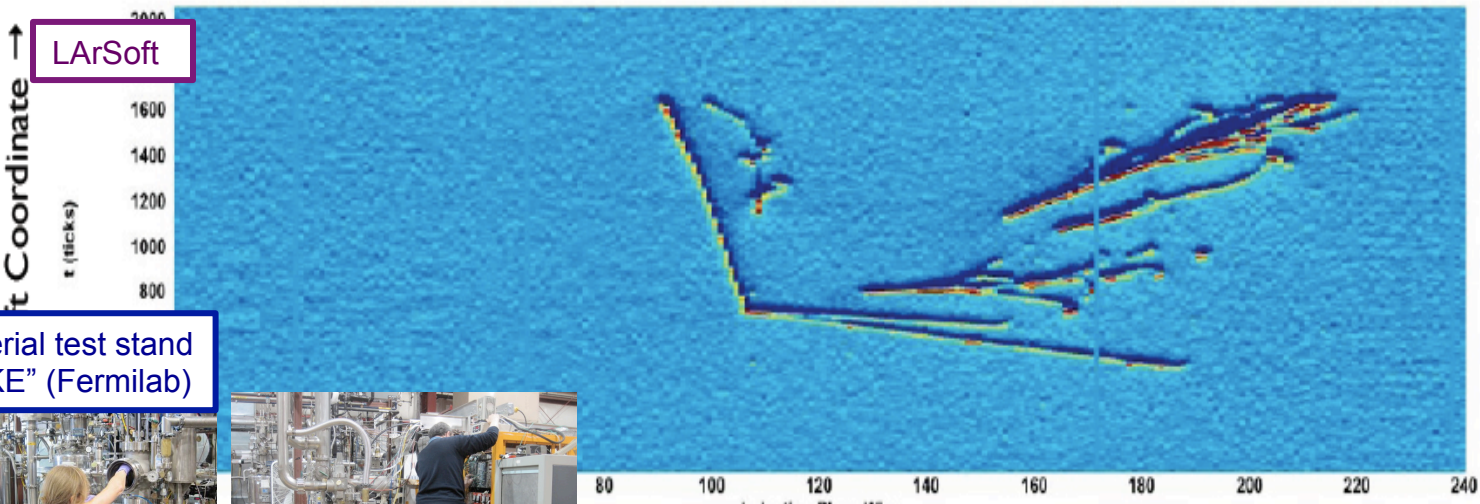

Material test stand
"LUKE" (Fermilab)



100%
R&D

Yale TPC

Electronics test stand
"Bo" (Fermilab)

2. Argon purification system

- Measure pollution of LAr by materials
- ~tenth of ppt purity
- gas and liquid phase measurement

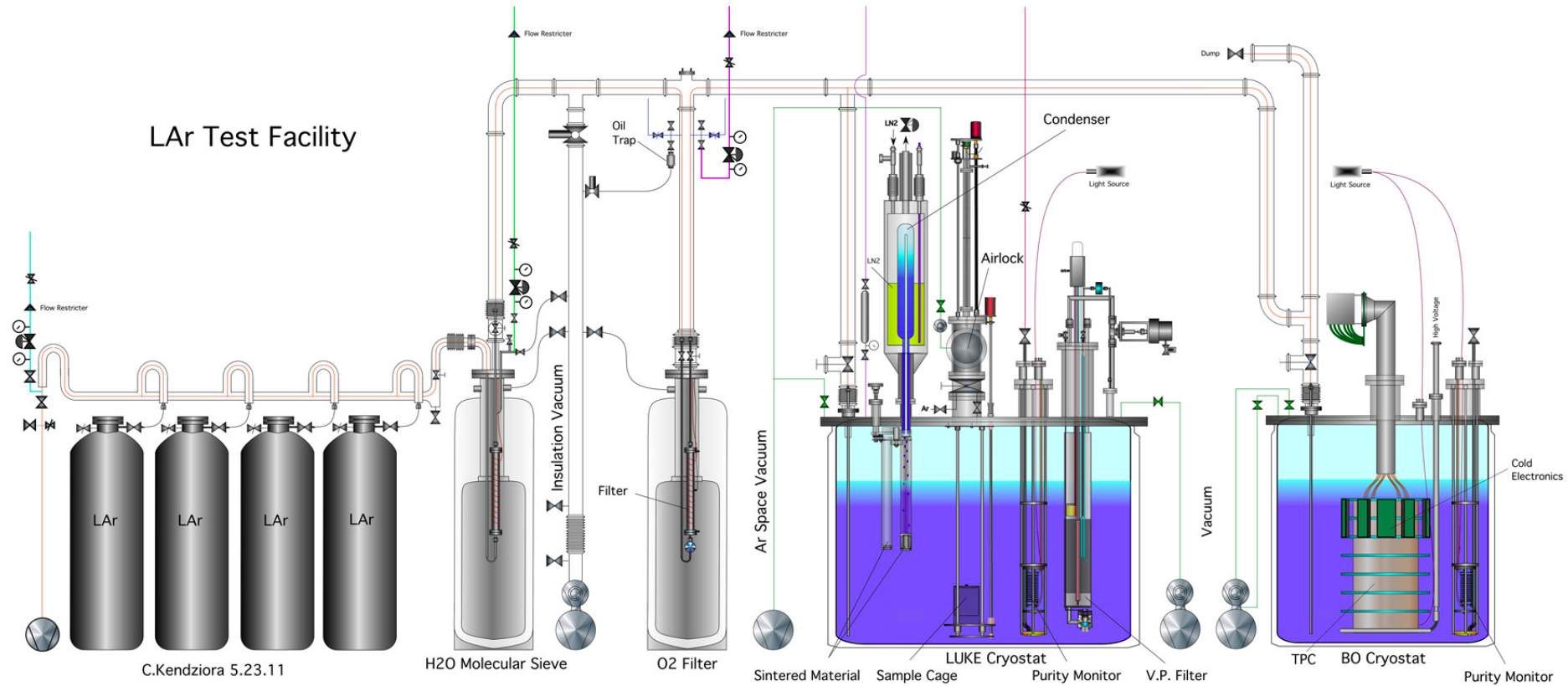

Argon purification system

Luke

Bo

2. Argon purification system

Measure pollution of LAr by materials

- ~tenth of ppt purity
- gas and liquid phase measurement

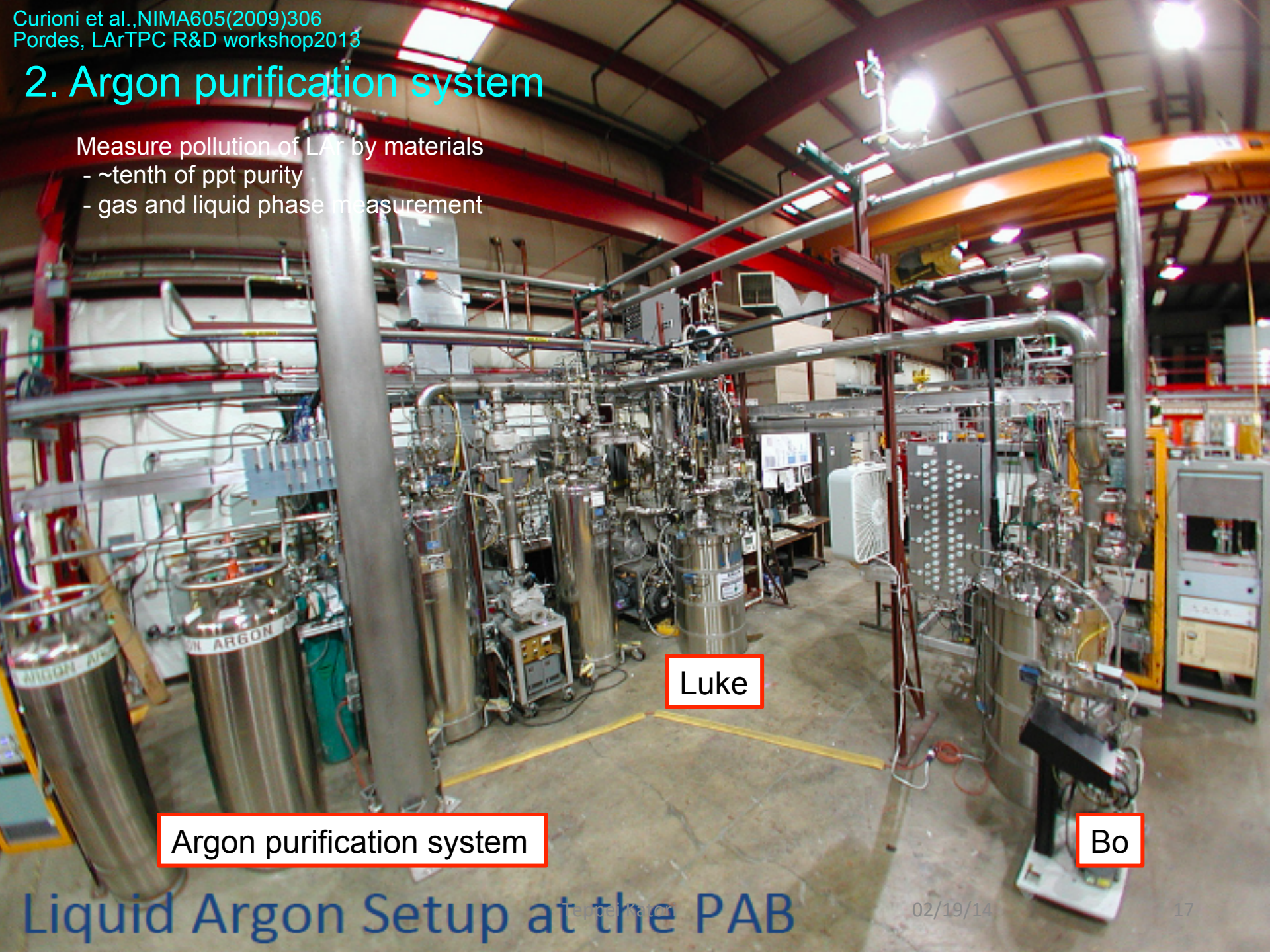

Argon purification system

Luke

Bo

2. Argon purification system

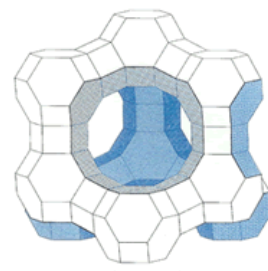

~600-1000m²/g

- Measure pollution of LAr by materials
- ~tenth of ppt purity
 - gas and liquid phase measurement

H₂O filter

O₂ filter

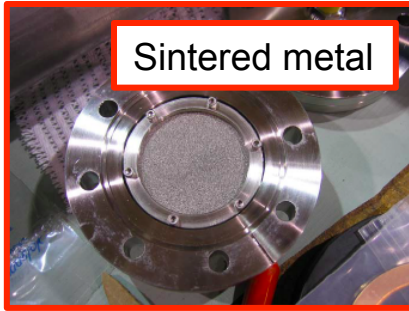

Sintered metal



Molecular sieve
(zeolite)



Activated copper
coated alumina

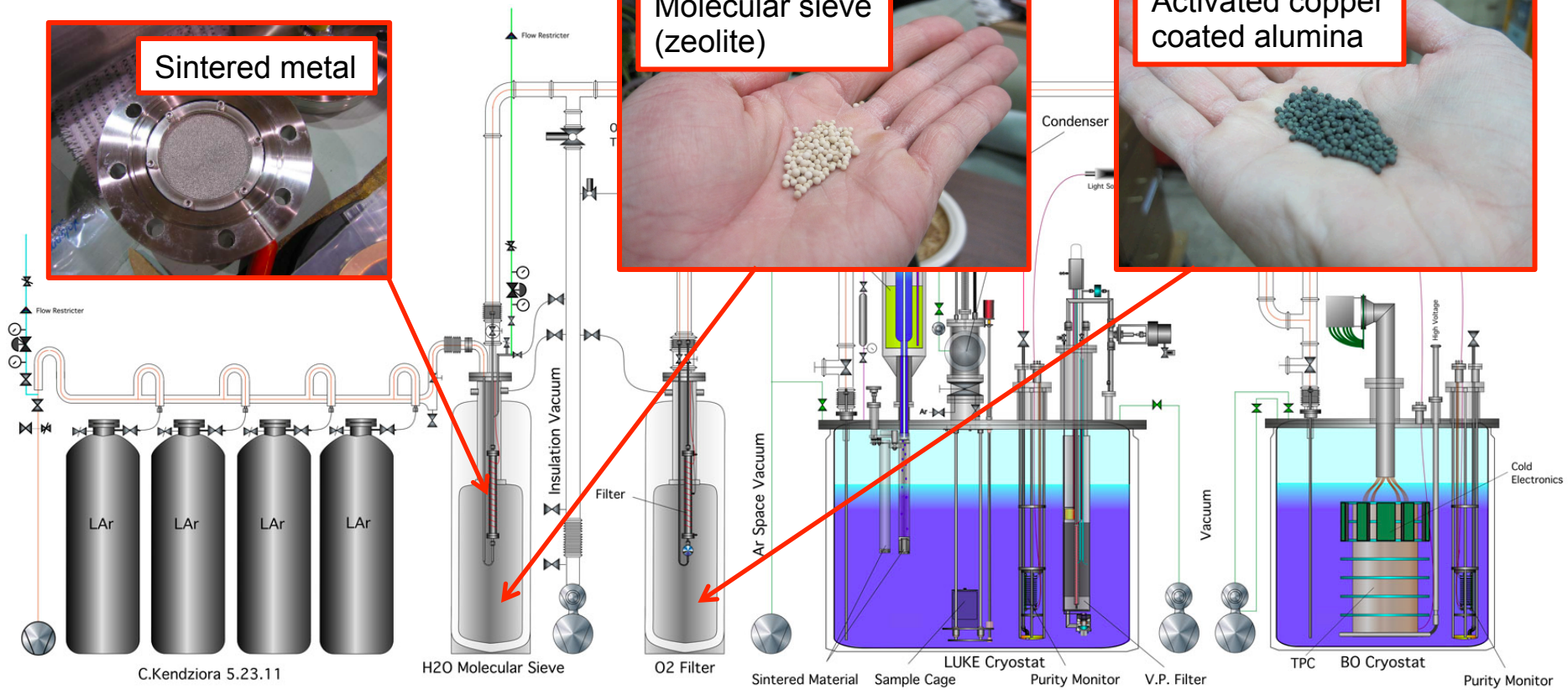

Argon purification system

Luke

Bo

2. Argon purification system

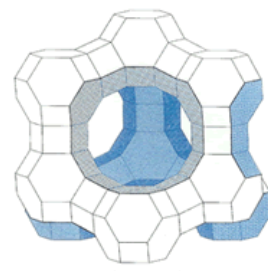

~600-1000m²/g

Measure pollution of LAr by materials

- ~tenth of ppt purity
- gas and liquid phase measurement

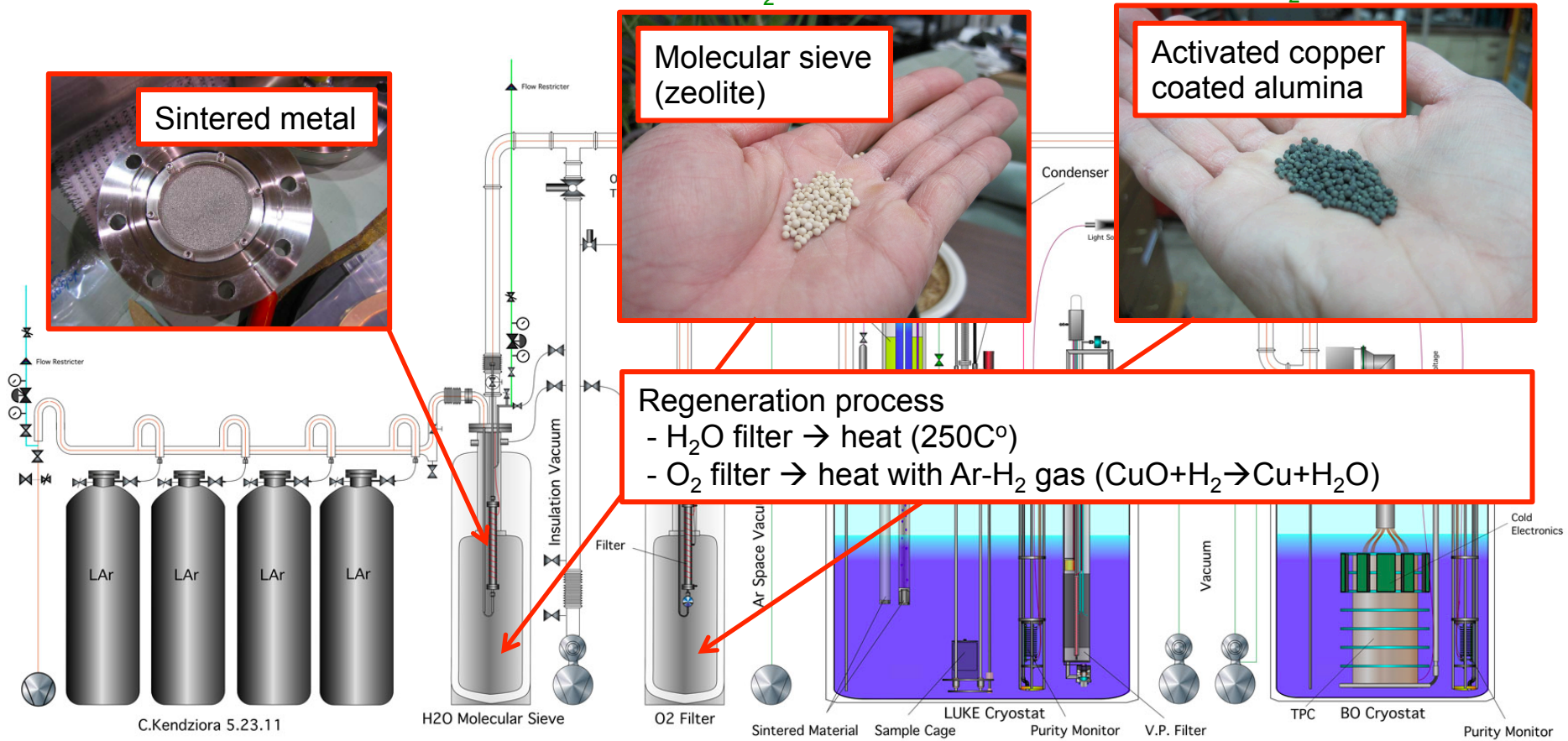

Argon purification system

Luke

Bo

2. Materials Test System (MTS), “Luke”

250L cryostat

- All materials used in inside of LArTPC cryostat must be tested by this (ArgoNeuT, MicroBooNE, etc)
- Measure the change of electron lifetime (=impurity concentration) by material insertion
- Both gas and liquid phase

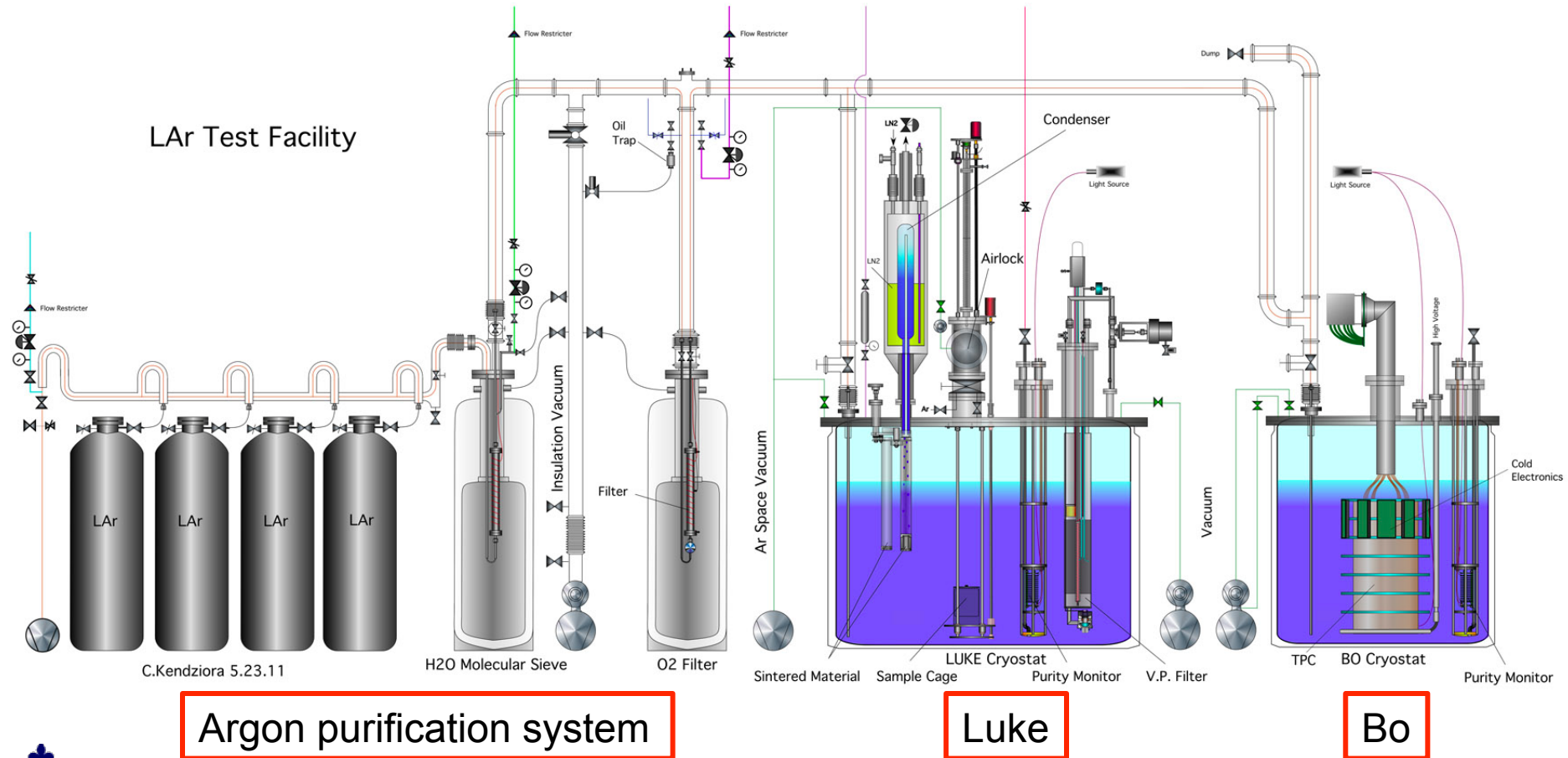

– Materials Test System

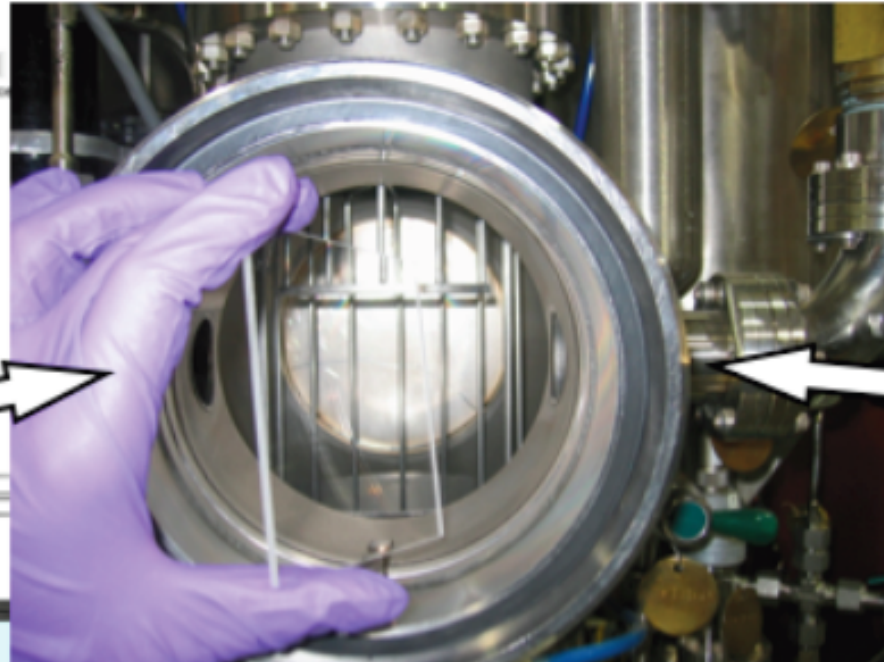
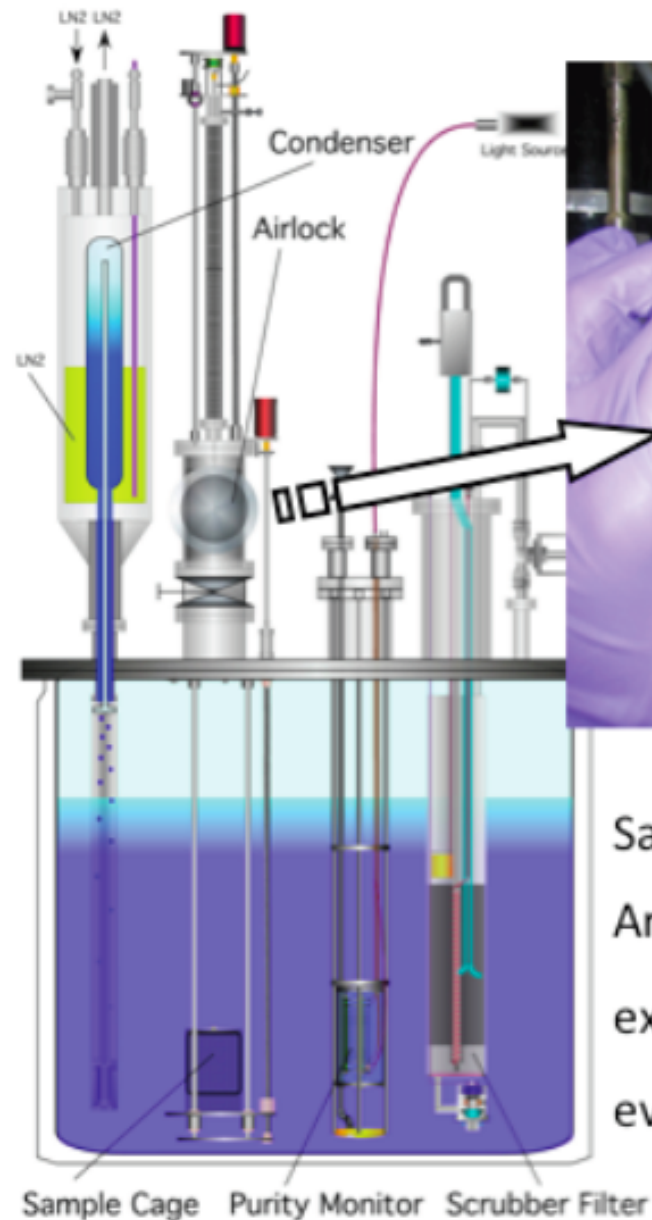

Sample volume 10 cm x 10 cm x 10 cm
Argonlock can be purged with
external argon, cryostat argon, and/or
evacuated

2. Materials Test System (MTS), “Luke”

Purity monitor

- Produce photo-electron by impinging UV light on gold plate
- Cathode and anode signal define electron life time

$$Q_{\text{anode}}/Q_{\text{cathode}} = e^{-t_{\text{drift}}/\tau}$$

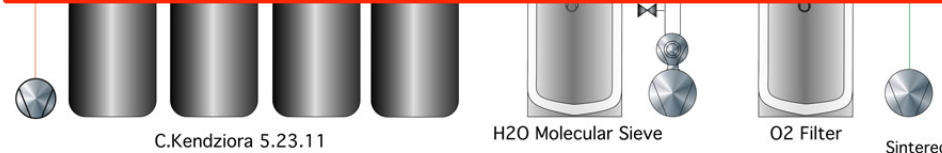
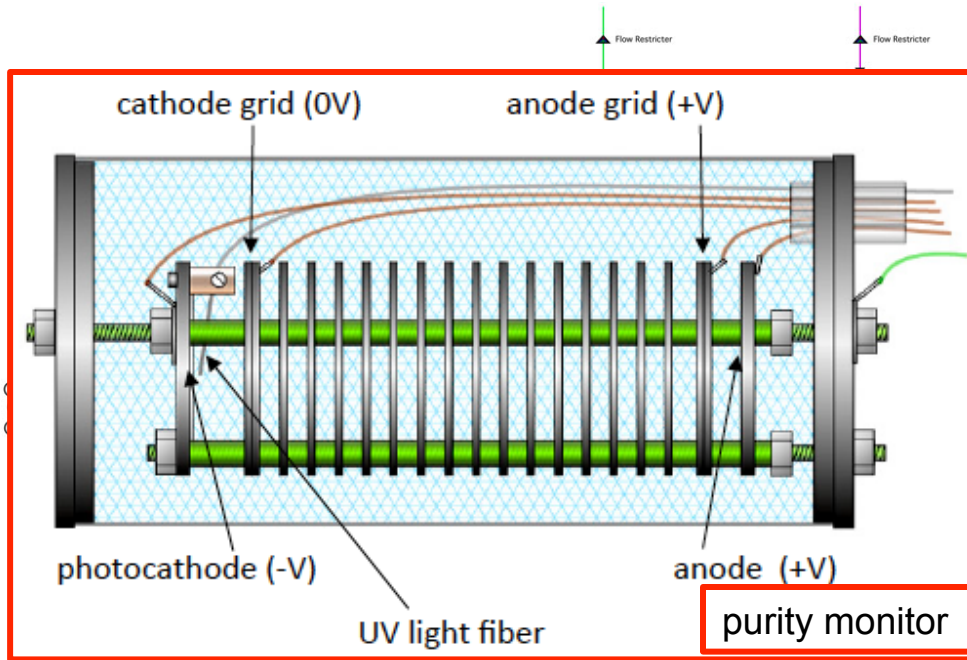

Argon purification system

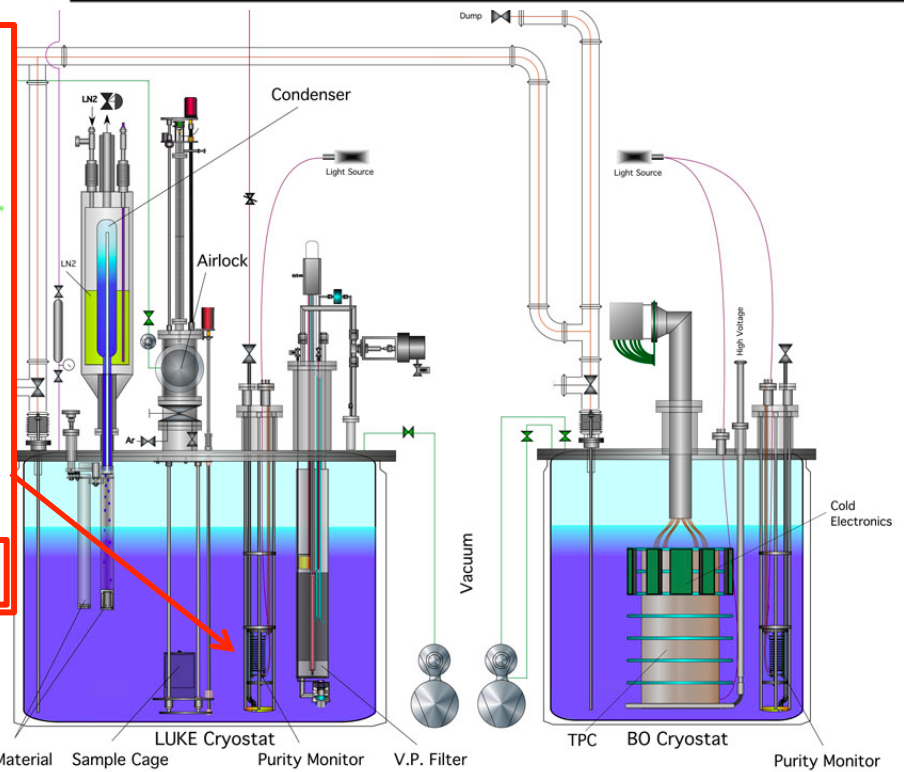

Luke

Bo

2. Materials Test System (MTS), “Luke”

FR4 (typical circuit board material)

- fiber glass (=contain lots of water), known “bad” material for LArTPC
- Impurity ceases to show up, it only appear gas phase running

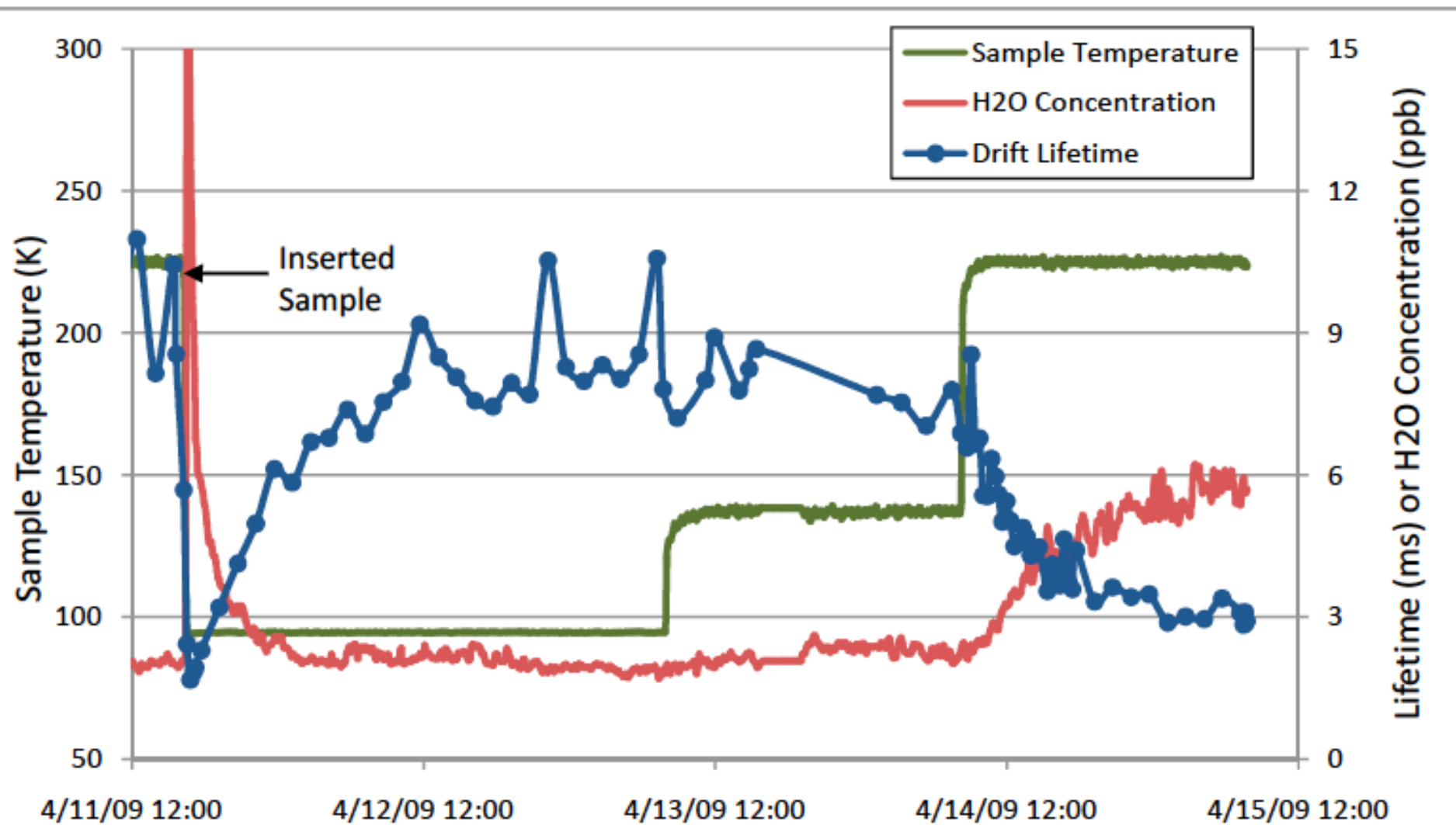

2. Materials Test System (MTS), "Luke"

FR4 (typical circuit board material)

- fiber glass (=contain lots of water), known "bad" material for LArTPC
- Impurity ceases to show up, it only appear gas phase running
- there is no material reduce electron life in liquid (problem happens when material is exposed in LAr gas)

Material	Date test started	Preparation	Tests	Water [ppb]	Lifetime [ms]	LogBook #
Cleaning Solution	6/29/09	evac. 24 h	vapor/liquid	4	5	946
Vespel	7/9/09	evac. overnite	liquid/vapor	5-7	2-5, 4-6	960
MasterBond glue	7/16/09	purged 18 h	vapor/liquid	1.6	1.3- 2.9	974
LEDs	7/31/09	purged 38 h	vapor	3.5	5	993
Carbon filter material	8/12/09	evac. 24 h	liquid/vapor	2	4-9	1000
962 FeedTru Board V2	10/12/09	evac. 24 h	vapor/warm	85	1-5	1062
Teflon cable	1/9/10	purged 28 h	warm/liquid/vapor	8-20	2-5	1175
3M "Hans" connectors	1/29/10	purged 46 h	warm/liquid/vapor	5-12	3	1198
962 capacitors	3/2/10	evac. 24 h	warm/liquid/vapor	6-14	3-6	1228
962 polyolefin cable	4/12/10	evac. 16 days	warm	25-60	2	1237
Rigaku feedthrough	4/20/10	purged 7.5 h	warm	15	3	1250
Rogers board (Teppei)	4/23/10	purged 26 h	warm/liquid/vapor	40	2, 6-10	1254
Arlon Board (Teppei)	5/14/10	evac. 0.5 h, pur.2 days	warm/vapor	300, 80	1.3, 3.5	1263
Polyethylene tubing	5/24/10	evac. 6 h, pur. 66 h	warm	300-500	1	1278
Teflon tubing	5/27/10	evac. 1 h, pur.17 h	warm	9-13	4-5	1283
Jonghee board	5/28/10	evac. 6 h, pur. 1.5 h	warm/vapor	100,28	1.2, 5-8	1285
Jonghee connectors	6/4/10	evac. 3.5 h, pur. 16 h	warm/vapor	50	2-3	1290
PVC cable	6/14/10	evac. 29 h, pur.1 h	warm	120	1-2	1296
Teppei TPB samples	8/3/10	purged 26 h	warm	600-1600	0.7	1342
Teppei TPB samples	9/4/10	purged 37 h	liquid /vapor	15, 300	6	
PrM feed tru (baked)	10/5/10	purged 25 h	warm/vapor	35, 20	3, 2	1396
Copper foil on mylar film	10/14/10	purged 26 h	warm/liquid/vapor	15, 10, 9	3, 8, 7	1409
Teppei SHV connector	10/25/10	purged 25 h	warm/vapor/liquid	35, 11, 0	2, 6, 6	1415
FR4	11/16/10	purged 25 h	warm/liquid/vapor	180, 20, 65	1.5, 6, 2.5	1429
Gaskets	3/11/11	purged 24 h	warm/liquid/vapor	8, 10	2.5, 8, 7	1521
LBNE AP-219 Color. Developer	4/13/11	purged 25 h	warm/vapor	65, 15	4, >6	1722
LBNE RPUF Foam	4/22/11	evac. 26 h, pur.1 h.	warm	800	0.2	1729
LAPD LEDs	5/12/11	purged 49 h	vapor	0.6 ppb	10	1769

2. Electronics test stand, “Bo”

General purpose R&D cryostat

- Test “cold” electronics
- Take cosmic ray data (filter function for Fourier transformation)
- Scintillation light test stand (later)

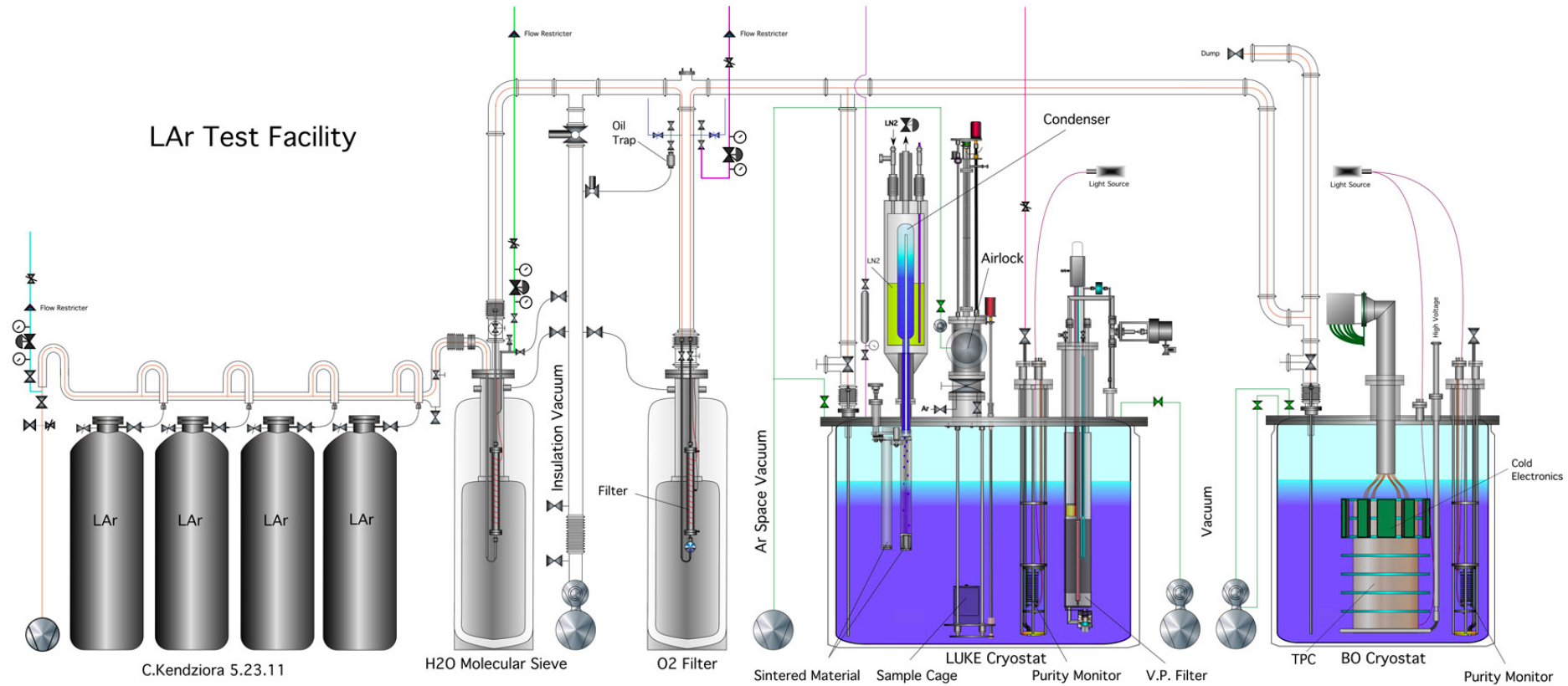

Argon purification system

Luke

Bo

1. USA LArTPC programs

100%
Physics

Path to the large LArTPC in USA

50%R&D
50%Physics

LArSoft

ArgoNeuT

Material test stand
"LUKE" (Fermilab)

100%
R&D

Yale TPC

Electronics test stand
"Bo" (Fermilab)

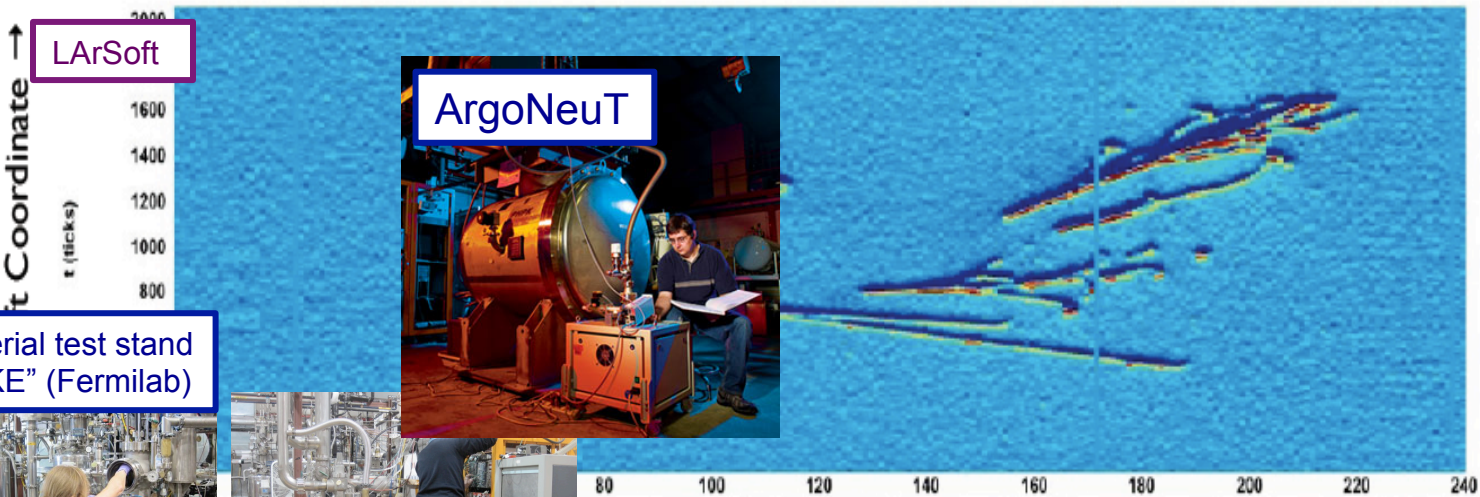

2007

2008

2010

2013

20??

2. ArgoNeuT

First USA LArTPC neutrino experiment

- Small fiducial volume, but MINOS ND as muon range
- NuMI neutrino beamline (wideband 3 GeV beam with tail up to 20 GeV)

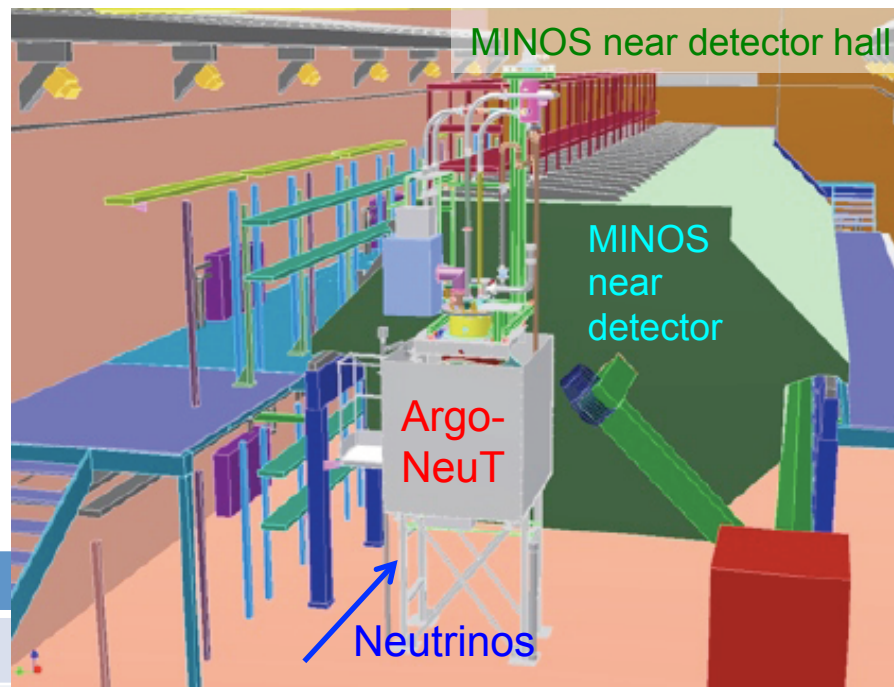

	ArgoNeuT
cryostat volume	0.7 ton
TPC volume	0.25 ton
# channel	480
wire pitch	4 mm
electronics style	JFET (293K)
max. drift length	0.5m (330ms)
light collection	none



2. ArgoNeuT

First USA LArTPC neutrino experiment

- Small fiducial volume, but MINOS ND as muon range
- NuMI neutrino beamline (wideband 3 GeV beam with tail up to 20 GeV)

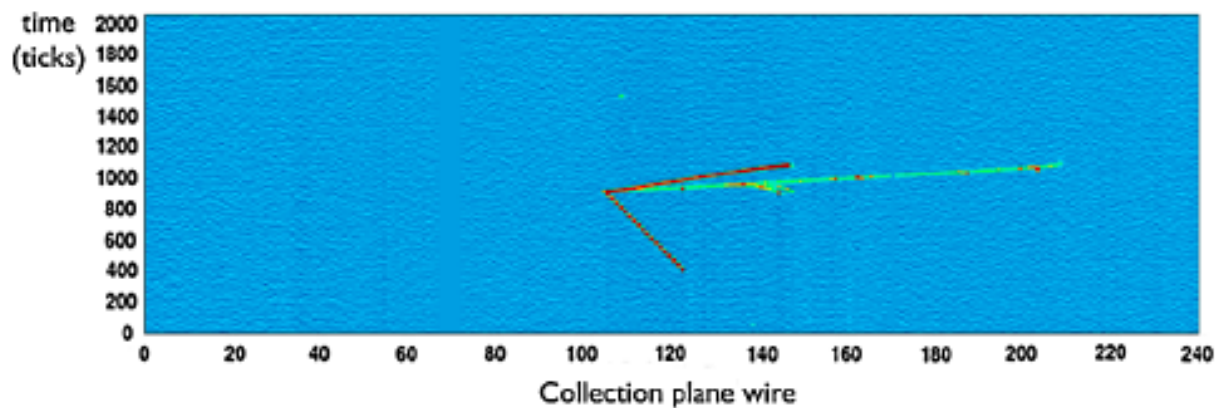
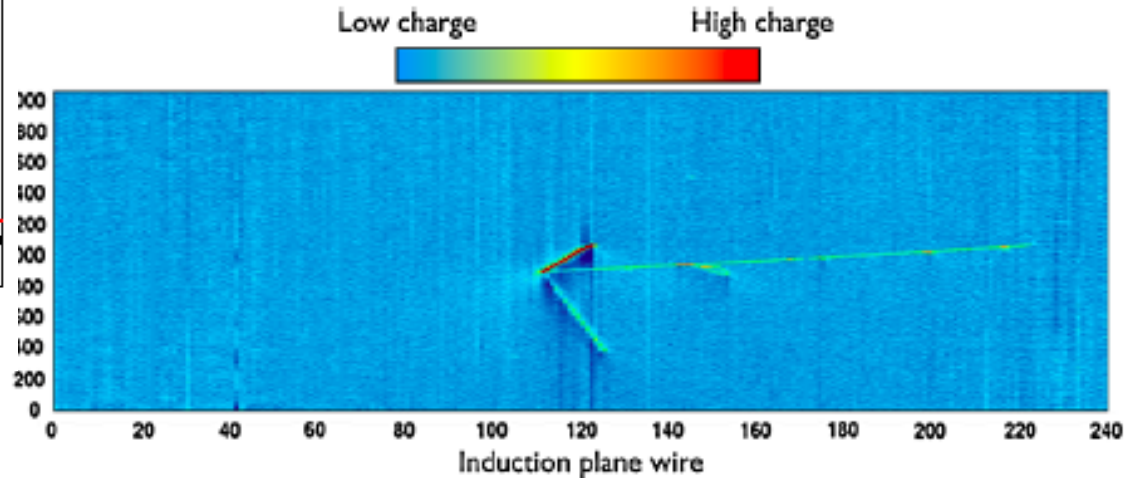
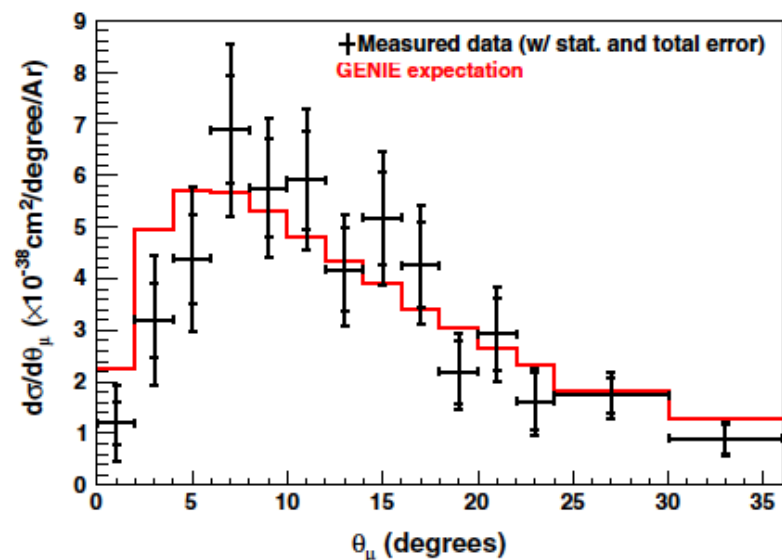

	ArgoNeuT
cryostat volume	0.7 ton
TPC volume	0.25 ton
# channel	480
wire pitch	4 mm
electronics style	JFET (293K)
max. drift length	0.5m (330ms)
light collection	none

2. ArgoNeuT

- First USA LArTPC neutrino experiment
- Small fiducial volume, but MINOS ND as muon range
 - NuMI neutrino beamline (wideband 3 GeV beam with tail up to 20 GeV)

ArgoNeuT can reconstruct such event which is total impossible with other detector...

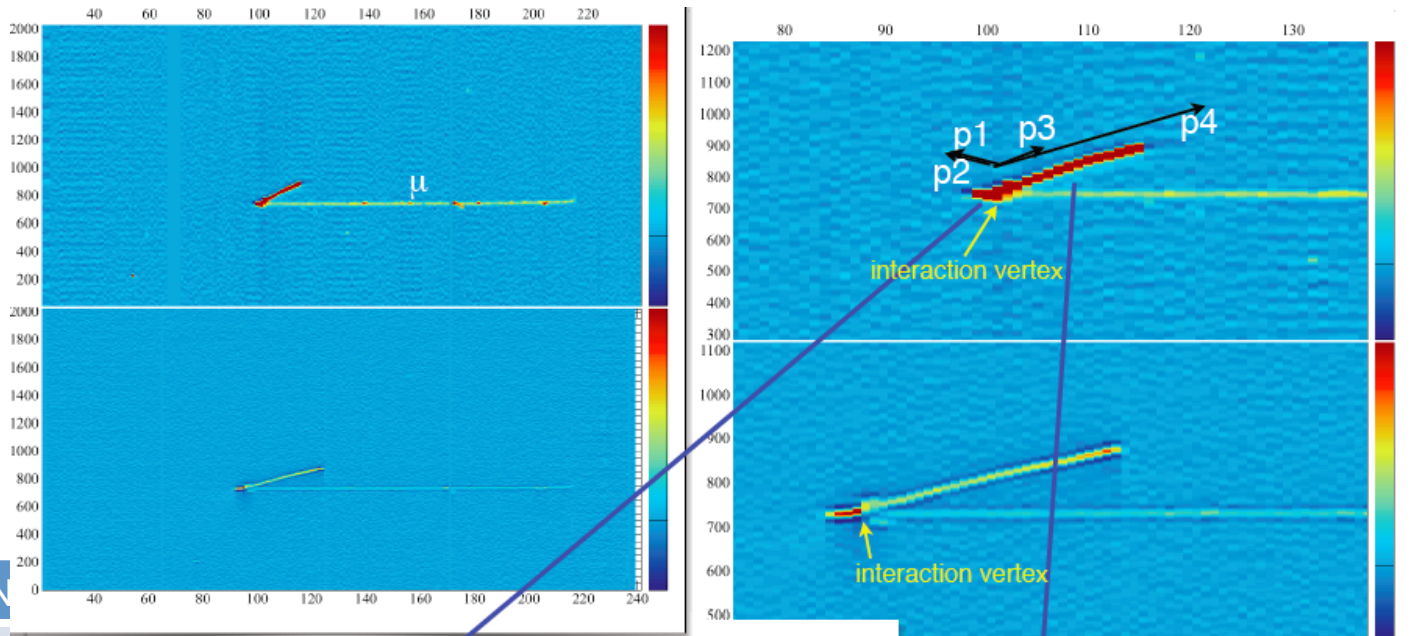

	ArgoNeuT
cryostat volume	0.7 t
TPC volume	0.25 t
# channel	4800
wire pitch	4 mm
electronics style	JFET (2000)
max. drift length	0.5m (3000)
light collection	non-imaging

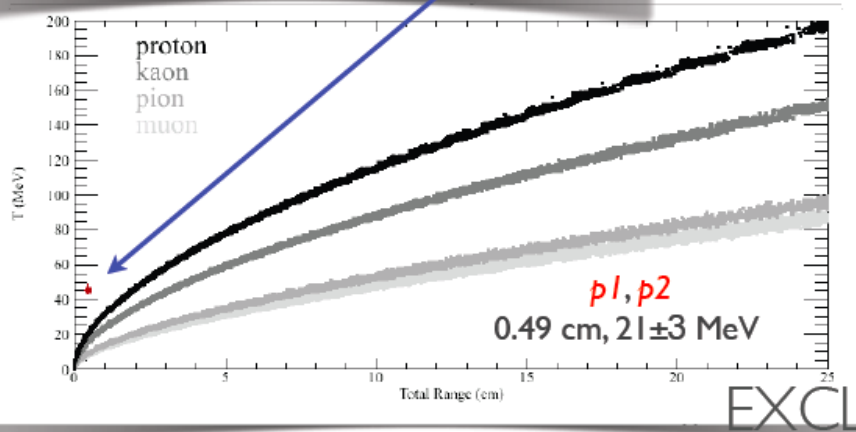

p4: 12 cm, 128±7 MeV
 p3: 0.6 cm, 24±3 MeV

compatible with
 1 μ 4p

DATA:

EXCLUSIVE TOPOLOGIES

1. USA LArTPC programs

100%
Physics

Path to the large LArTPC in USA

50%R&D
50%Physics

LArSoft

ArgoNeuT

Material test stand
"LUKE" (Fermilab)

100%
R&D

Yale TPC

Electronics test stand
"Bo" (Fermilab)

LAPD

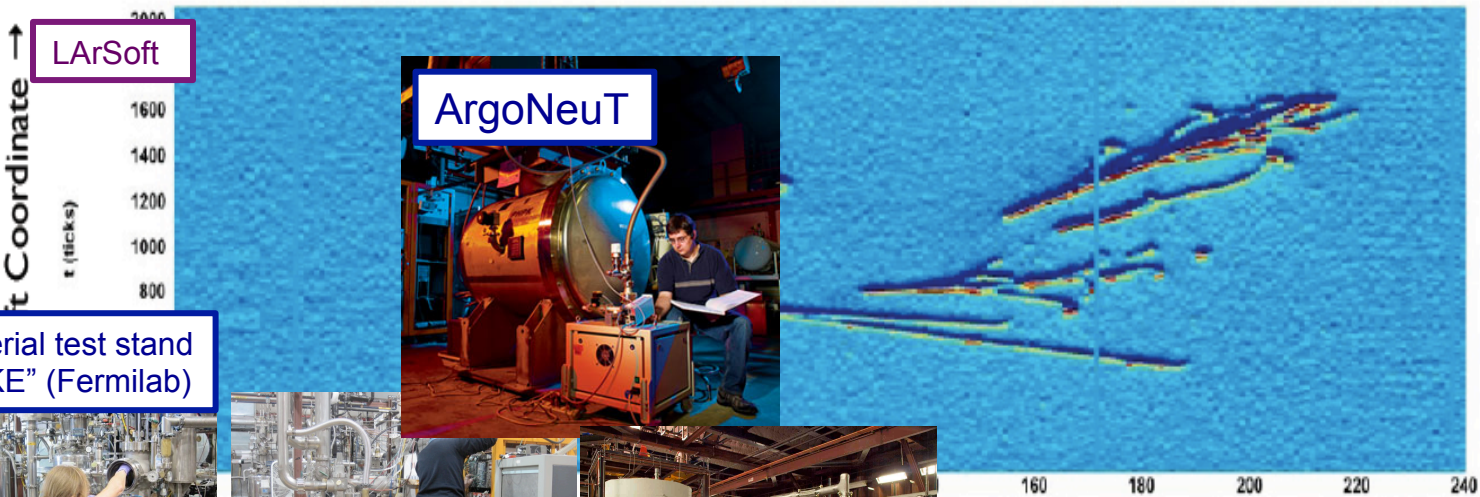

2007

2008

2010

2013

20??

2. LAPD (Liquid Argon Purity Demonstrator)

Large cryostat to achieve high purity without evacuation

- Purging room temperature argon gas to push out impurity
- It can achieve sub ppb purity after 1 week purging with recirculating argon gas (with filter)
- LAPD measure temperature, purity at various location
- Later, TPC is installed (long Bo)

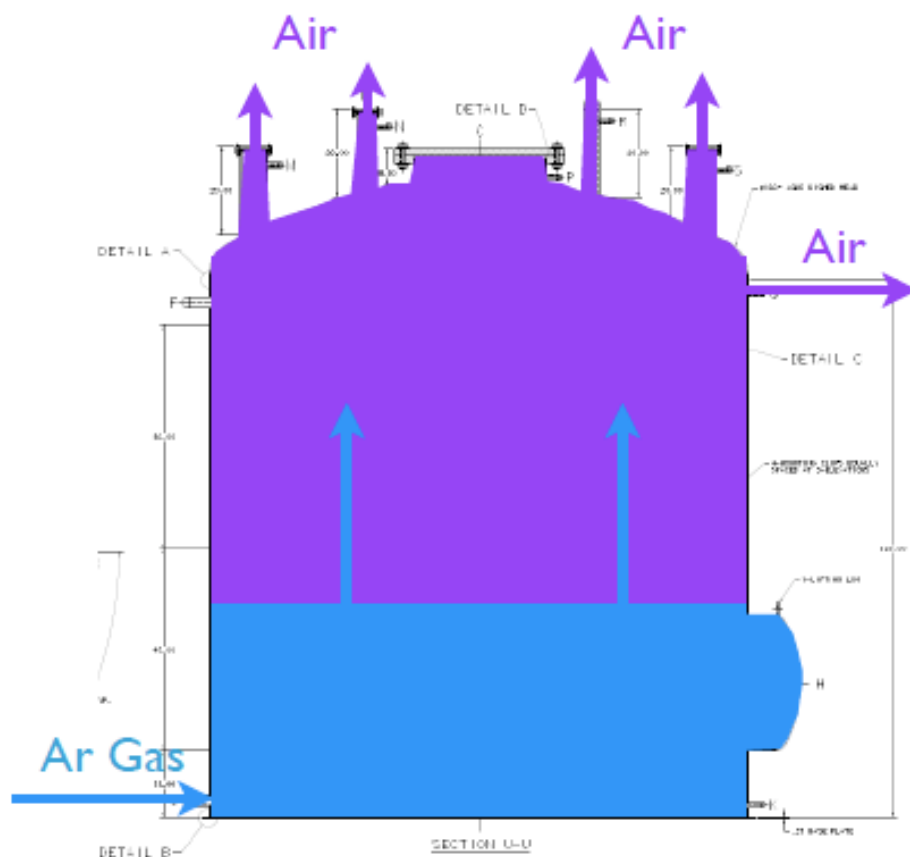

Liquid Argon Purity Demonstrator (LAPD)



2. LAPD (Liquid Argon Purity Demonstrator)

Large cryostat to achieve high purity without evacuation

- Purging room temperature argon gas to push out impurity
- It can achieve sub ppb purity after 1 week purging with recirculating argon gas (with filter)
- LAPD measure temperature, purity at various location
- Later, TPC is installed (long Bo)

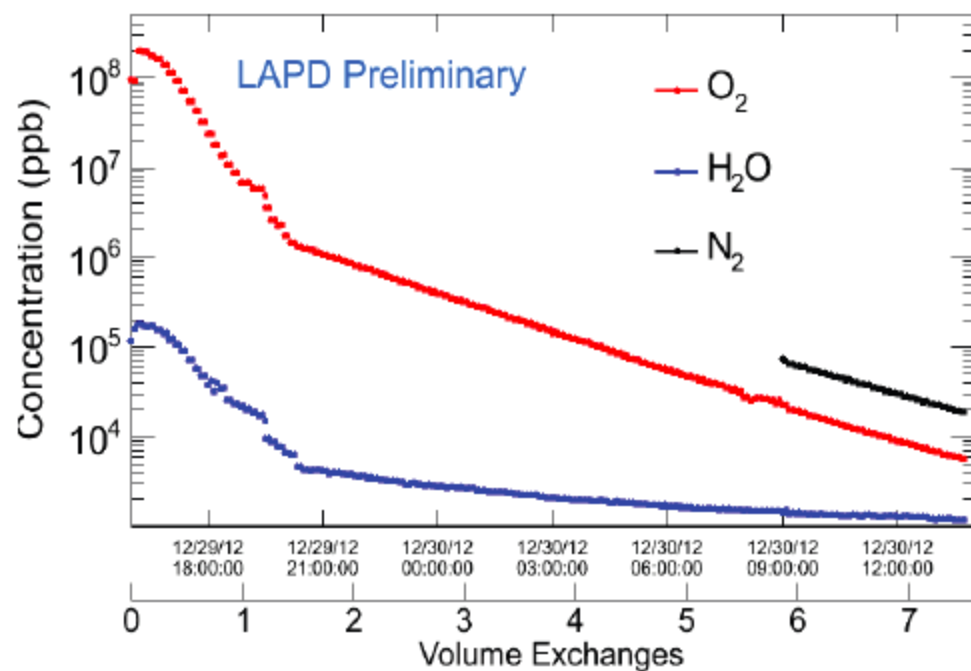

Liquid Argon Purity Demonstrator (LAPD)



1. USA LArTPC programs

100%
Physics

Path to the large LArTPC in USA

50%R&D
50%Physics

100%
R&D

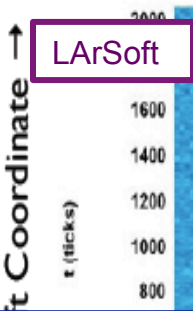

Material test stand
"LUKE" (Fermilab)



Electronics test stand
"Bo" (Fermilab)



2007

2008

2010

2013

20??

2. MicroBooNE

MiniBooNE low energy excess

- MiniBooNE cannot distinguish electron and photon

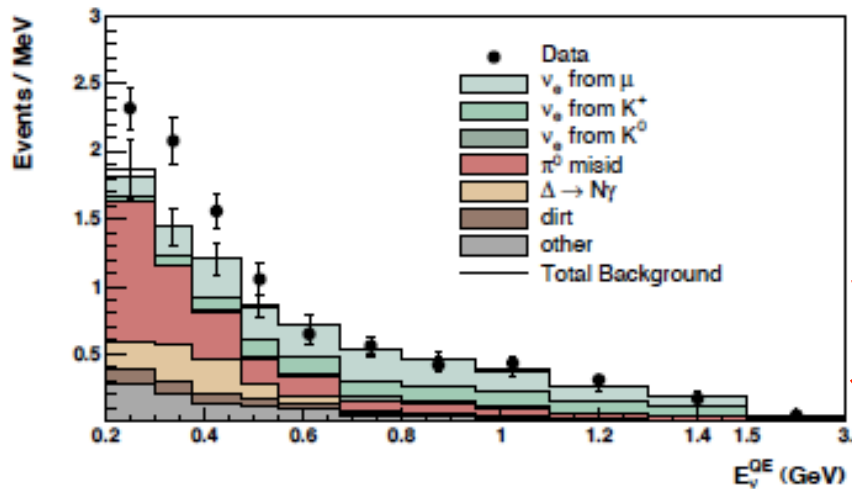

MicroBooNE electron like sample

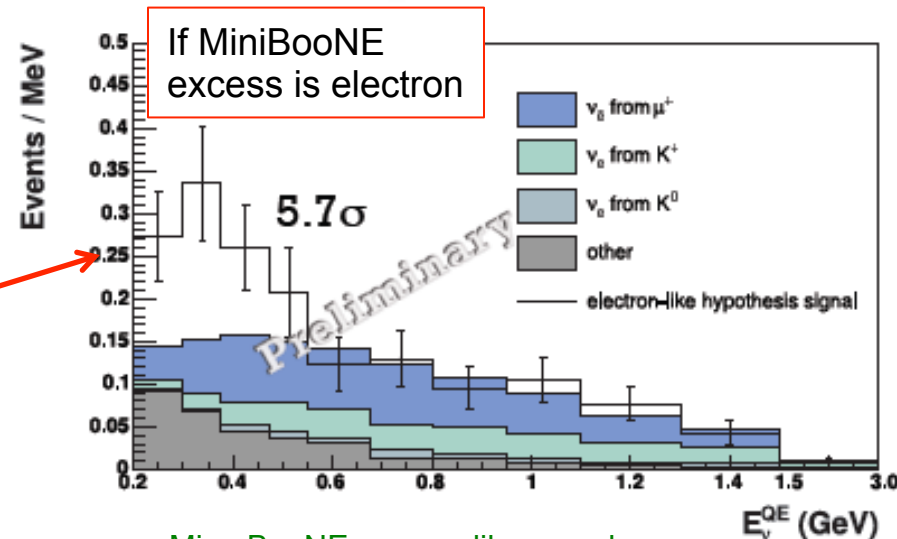

MicroBooNE gamma like sample

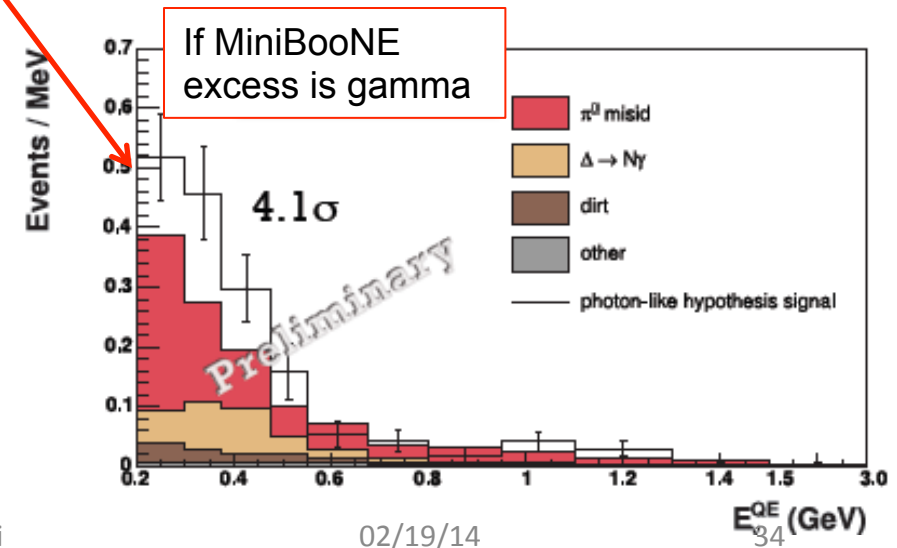

	ArgoNeuT	MicroBooNE
cryostat volume	0.7 ton	150 ton
TPC volume	0.25 ton	86 ton
max. drift length	0.5m (330ms)	2.5m (1.5ms)
electronics style	JFET (293K)	CMOS (87K)
# channel	480	~8,000
wire pitch	4 mm	3 mm
# wire plane	2	3
light collection	none	30 of 8" PMT

2. MicroBooNE

Path to large LArTPC

- Roughly half size of ICARUS T300
- Booster Neutrino Beamline (wideband 800 MeV peak)
- All specs are improved from ArgoNeuT
 - more channels, denser wires, more planes
 - longer drift length (=need purer LAr)
 - cold electronics (closer FEB, lower CMOS noise)
 - photon collection system (later)
- Not vacuum insulated (foam insulated), $<15\text{W/m}^2$
- Surface running

	ArgoNeuT	MicroBooNE
cryostat volume	0.7 ton	150 ton
TPC volume	0.25 ton	86 ton
max. drift length	0.5m (330ms)	2.5m (1.5ms)
electronics style	JFET (293K)	CMOS (87K)
# channel	480	~8,000
wire pitch	4 mm	3 mm
# wire plane	2	3
light collection	none	30 of 8" PMT



2. MicroBooNE

Path to large LArTPC

- Roughly half size of ICARUS T300
- Booster Neutrino Beamline (wideband 800 MeV peak)
- All specs are improved from ArgoNeuT
 - more channels, denser wires, more planes
 - longer drift length (=need purer LAr)
 - cold electronics (closer FEB, lower CMOS noise)
 - photon collection system (later)
- Not vacuum insulated (foam insulated), $<15\text{W/m}^2$
- Surface running

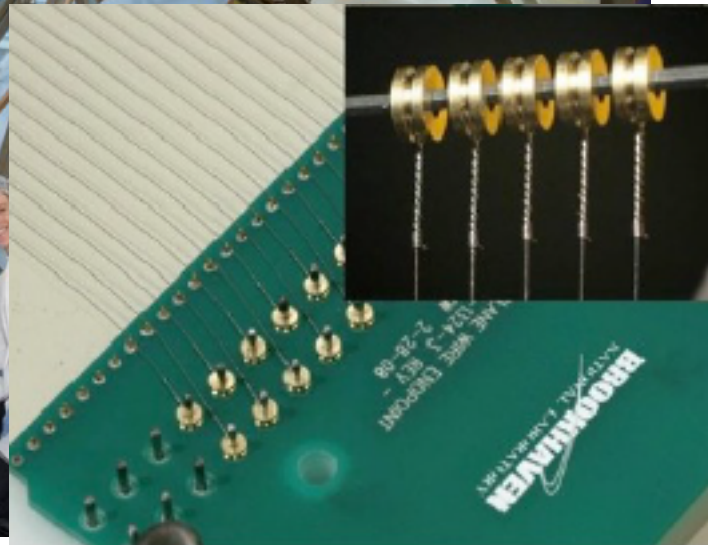
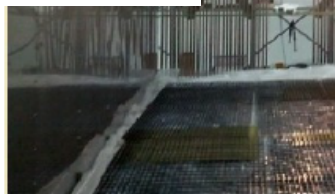

2. MicroBooNE

Cathode

Anode

-128 kV

$E = 500 \text{ V/cm}$

Field Cage

3 wire planes (vertical, +/- 60°) 3mm spacing

HV Feedthrough

Tubes are connected with 250MΩ resistors for field uniformity

BROOKHAVEN
T PLANE WIRE CARRIER - BOTTOM
6-024-3 REV B
LAP 9-10-11

The image shows a detailed view of the MicroBooNE detector's field cage. A large photograph on the left shows the interior of the detector with a cathode on the left and an anode on the right. A voltage of -128 kV is applied to the cathode, creating a uniform electric field of 500 V/cm. A field cage of 3mm diameter tubes is positioned between the cathode and anode. A diagram at the bottom left shows a cross-section of the HV feedthrough. A close-up on the right shows the 3 wire planes (vertical, +/- 60°) with 3mm spacing. A photograph at the bottom right shows the Brookhaven T Plane Wire Carrier - Bottom, which is connected to the field cage tubes with 250MΩ resistors for field uniformity.

1. USA LArTPC programs

100%
Physics

Path to the large LArTPC in USA

50%R&D
50%Physics

100%
R&D

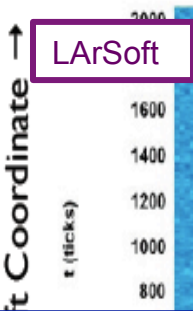

2007

2008

2010

2013

20??

2. LBNE35ton prototype

Membrane cryostat

- Only viable technology of large cryostat

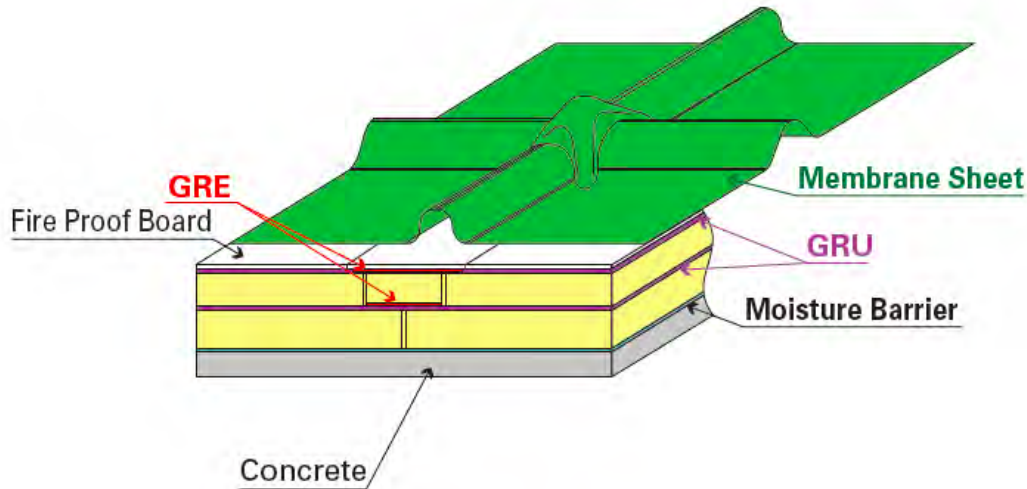

GRE: Glass Cloth Reinforced Epoxy
GRU: Glass Cloth Reinforced urethane

worker



216,000m³ LNG tanker (~300 kt of LAr)



The LNGC "Tembek", one of the thirty-one 216,000 m³ LNG carriers ordered by Nakilat and delivered in 2008

2. LBNE35ton prototype



2. LBNE35ton prototype



2. LBNE35ton prototype



1. USA LArTPC programs

100%
Physics

Path to the large LArTPC in USA

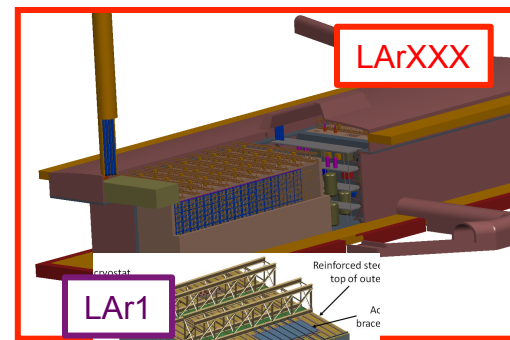

MicroBooNE



Captain



LArIAT

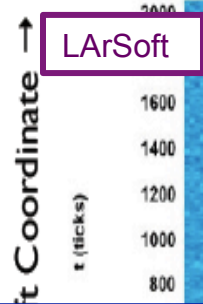

ArgoNeuT

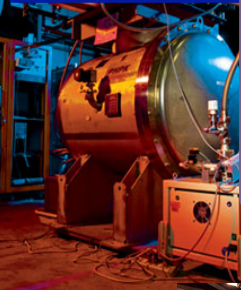

LBNE 35ton



Material test stand
"LUKE" (Fermilab)



Electronics test stand
"Bo" (Fermilab)

Yale TPC



LAPD



50%R&D
50%Physics

100%
R&D

2007

2008

2010

2013

20??

2. LBNE

Future large LArTPC

- Now LAr20 (2 modules, 10 kton each)
- To pass CD1, LBNE default plan accepted 3 humiliating conditions
 - smaller fiducial mass (34kton→10kton)
 - no near detector (it is essential for oscillation physics!)
 - surface running (no astrophysics, no proton decay)
- all of these have to be fixed before CD2 (2016)
- Light guide idea for photon detection (later)

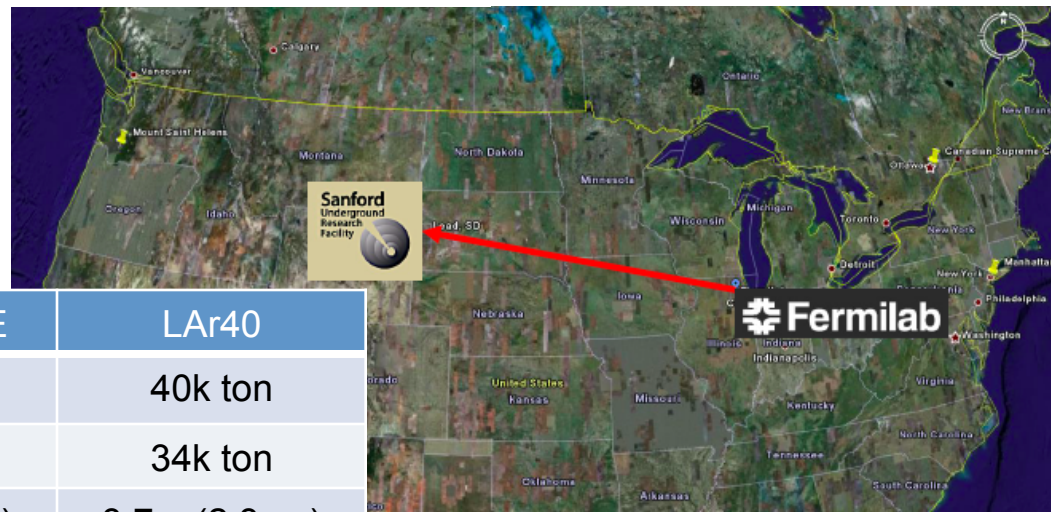

	ArgoNeuT	MicroBooNE	LAr40
cryostat volume	0.7 ton	150 ton	40k ton
TPC volume	0.25 ton	86 ton	34k ton
max. drift length	0.5m (330ms)	2.5m (1.5ms)	3.7m (2.3ms)
electronics style	JFET (293K)	CMOS (87K)	CMOS (87K)
# channel	480	~8,000	~266,000
wire pitch	4 mm	3 mm	5 mm
# wire plane	2	3	3
light collection	none	30 of 8" PMT	light guide

NEWS SCIENCE & ENVIRONMENT

Home World UK England N. Ireland Scotland Wales Business Politics Health Education Sci/Environment Technology Entertainment & Arts



Neutrino beam 'major physics experiment'

1 hour ago

The UK will be part of what is being described as one of the biggest physics experiments ever built, in an effort to learn more about the creation of the universe.

Researchers will fire a beam of particles called neutrinos through 1,300km (800 miles) of rock - from their lab near Chicago to a location in South Dakota.

The UK's role in the \$1.5bn (£1bn) project will be to help to build a giant neutrino detector, likely to be about 12m (39ft) across.

Studying how the particles change as they travel will give a deeper

Related video / audio



Dark matter hunt in US gold mine
30 May 2012

Most watched



Somerset floods 'up to door knocker'
1 hour ago



Aerial video shows submerged homes
4 hours ago



William and Harry shift sandbags
8 hours ago



'Streets awash with sewage' in Surrey
59 minutes ago



Chertsey 'sausage' angers residents
14 February 2014

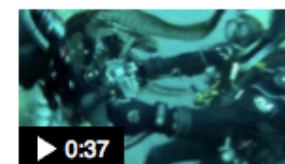

Octopus wrestles with US cameraman
14 February 2014

Show More

2. LBNE

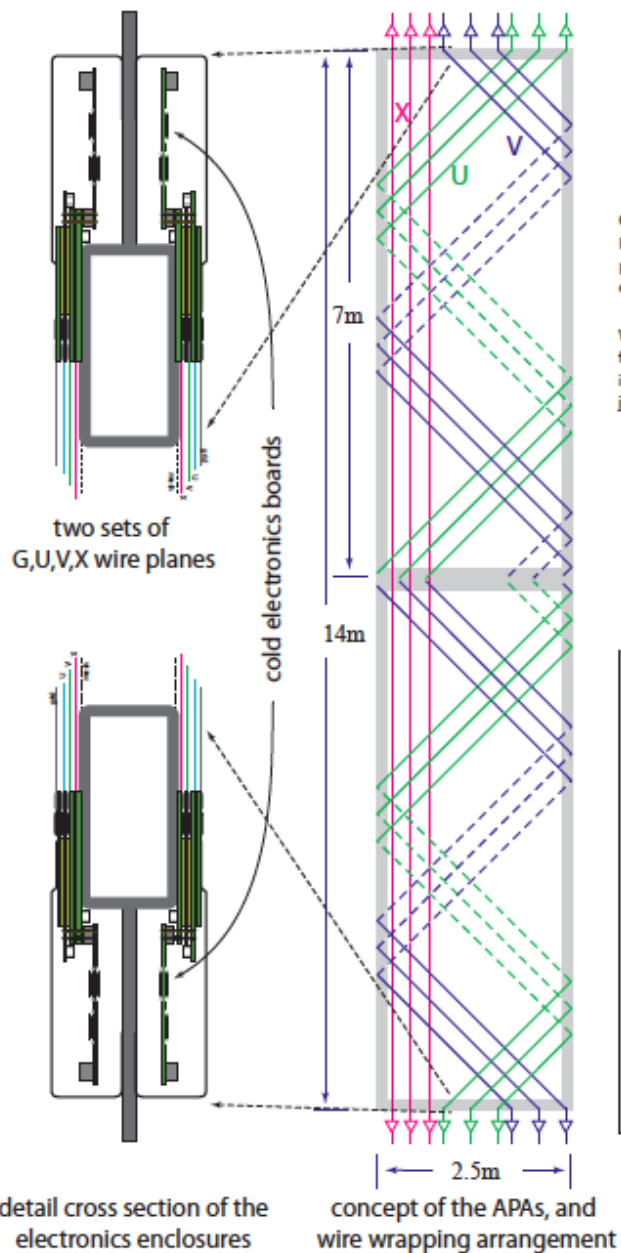

installation of APAs inside the cryostat

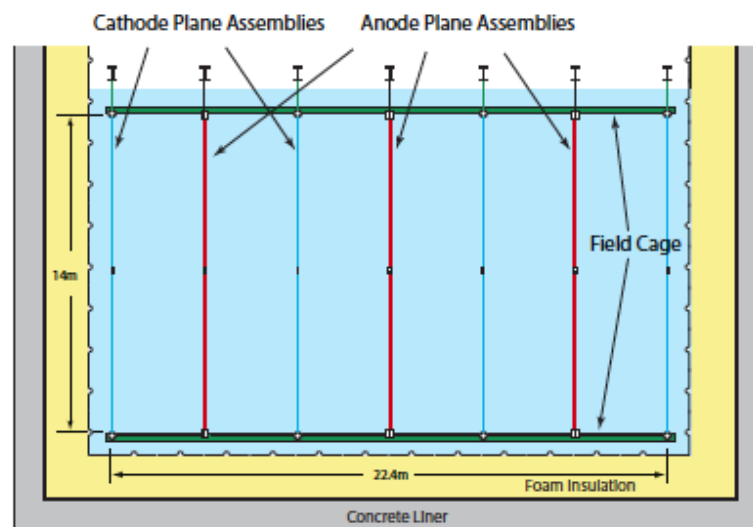
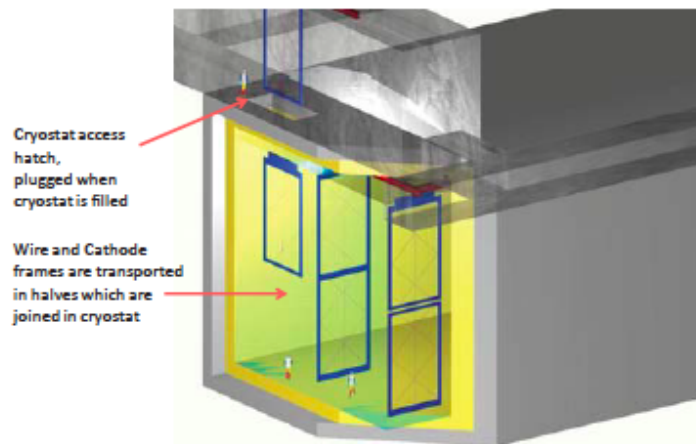

cross section view of the TPC components inside the cryostat

1. Introduction
2. US LArTPC programs
- 3. LAr photon detection R&D**
4. Challenge of LArTPC technology
5. Conclusion

3. Scintillation light from argon

Noble gas comparison

- lower boiling point is easier to handle
- higher density has more energy deposit
- longer wavelength is easier to detect
- Xe>Kr>Ar>Ne>He but Xe and Kr are expensive



	He	Ne	Ar	Kr	Xe	Water
Boiling Point [K] @ 1atm	4.2	27.1	87.3	120.0	165.0	373
Density [g/cm ³]	0.125	1.2	1.4	2.4	3.0	1
Radiation Length [cm]	755.2	24.0	14.0	4.9	2.8	36.1
Scintillation [γ /MeV]	19,000	30,000	40,000	25,000	42,000	
dE/dx [MeV/cm]	0.24	1.4	2.1	3.0	3.8	1.9
Scintillation λ [nm]	80	78	128	150	175	

3. Scintillation light from argon

Argon as gas scintillator

Organic scintillator (PPO, POPOP, PBD, etc)

- S0-S1 excitation of π -electron

Inorganic scintillator (NaI(Tl), etc)

- Crystal with impurity

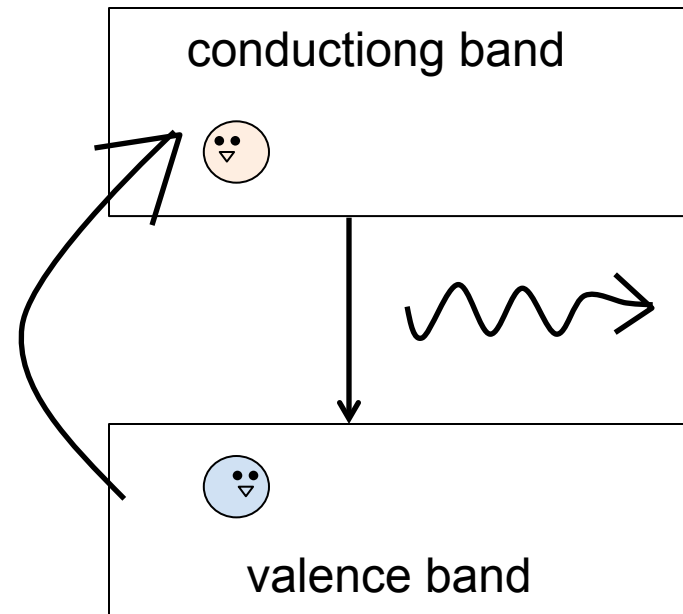
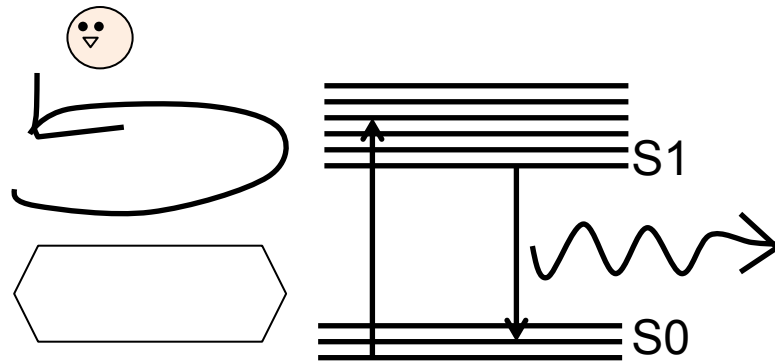

3. Scintillation light from argon

Argon as gas scintillator

- 2 excitation path, singlet (spin 0) and triplet (spin 1)
- prompt signal can be used for trigger
- delayed signal is sensitive to impurity (nitrogen)
- both vacuum UV (128nm)

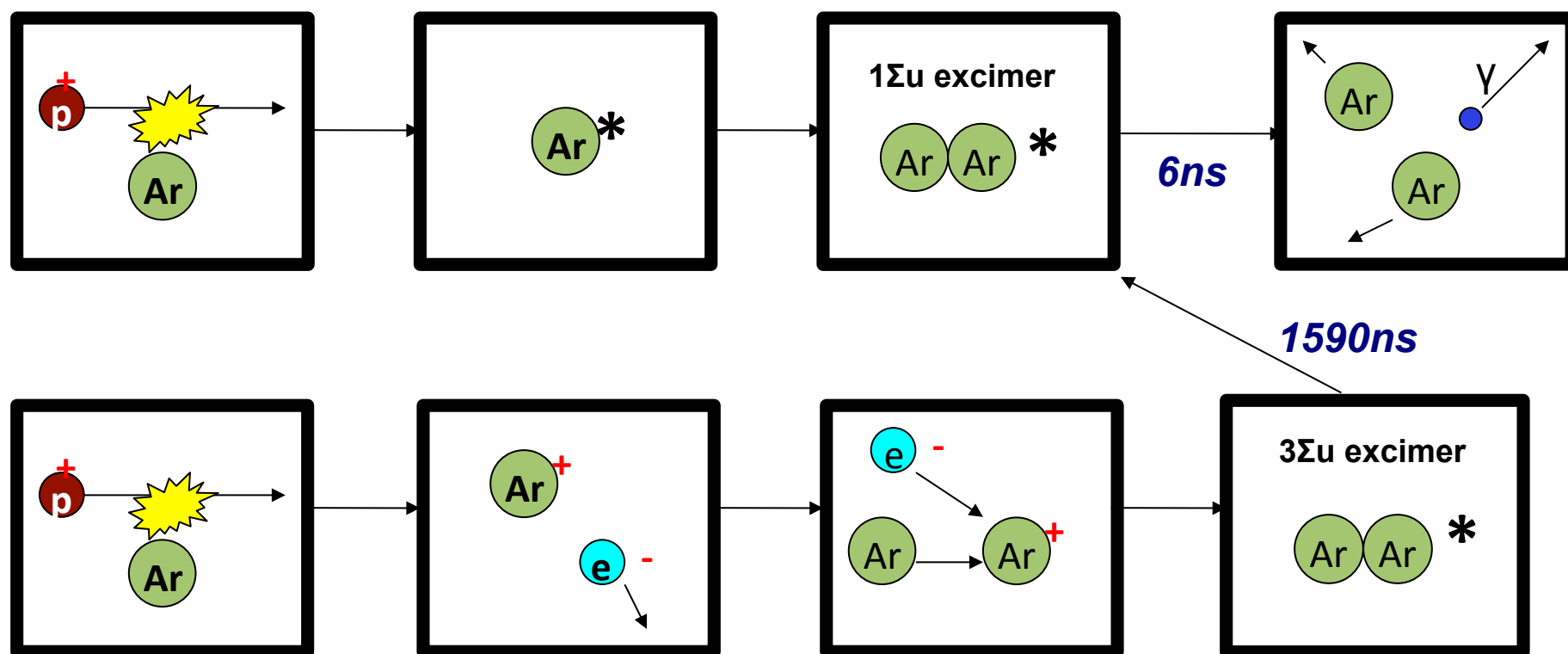

3. Scintillation light from argon

Argon as gas scintillator

- 2 excitation path, singlet (spin 0) and triplet (spin 1)
- prompt signal can be used for trigger
- delayed signal is sensitive to impurity (nitrogen)
- both vacuum UV (128nm)

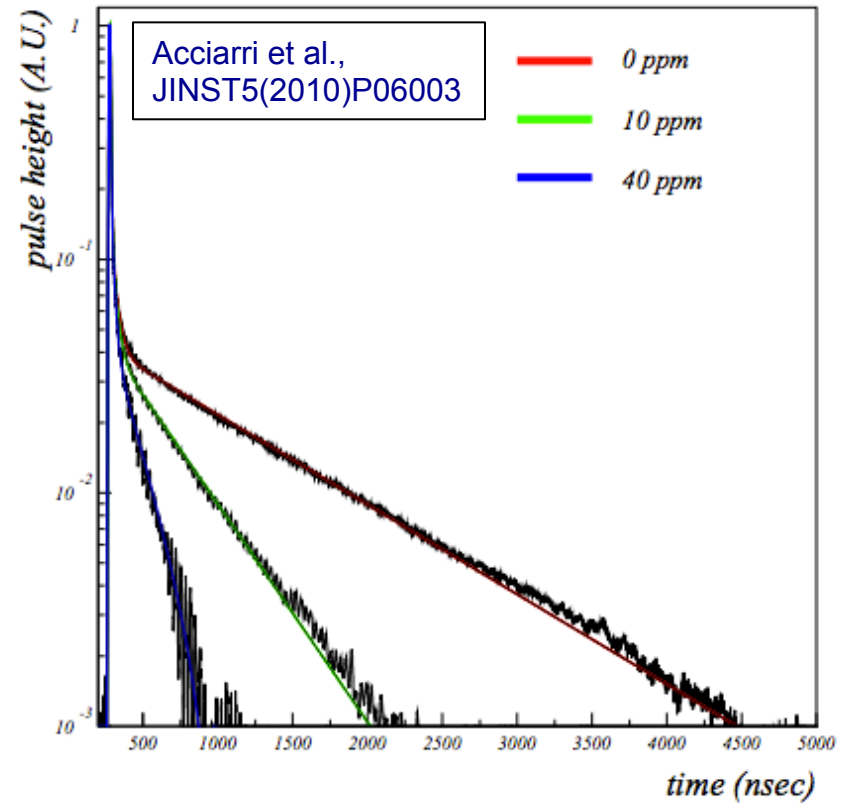
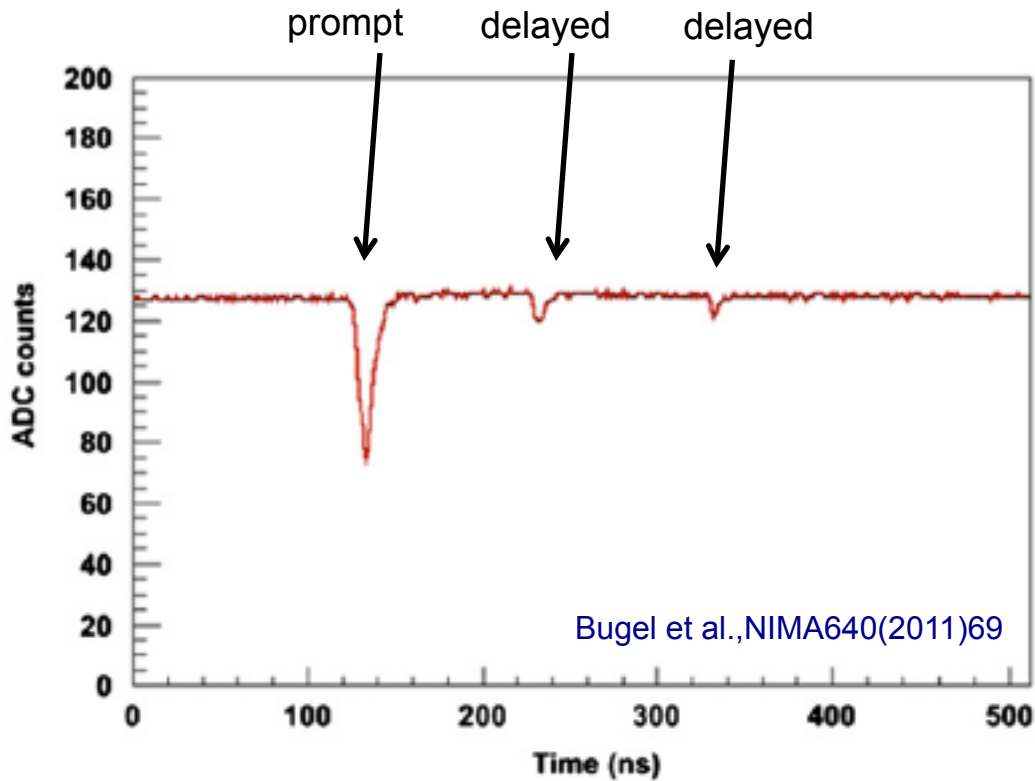

3. Scintillation light from argon

TPB (tetraphenyl butadiene)

- convert 128nm to blue (efficiency > 100%?!)
- degrade by UV light (possibly by humidity, too)

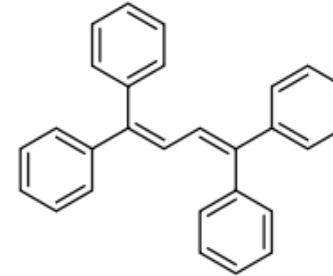

TPB plate performance degradation

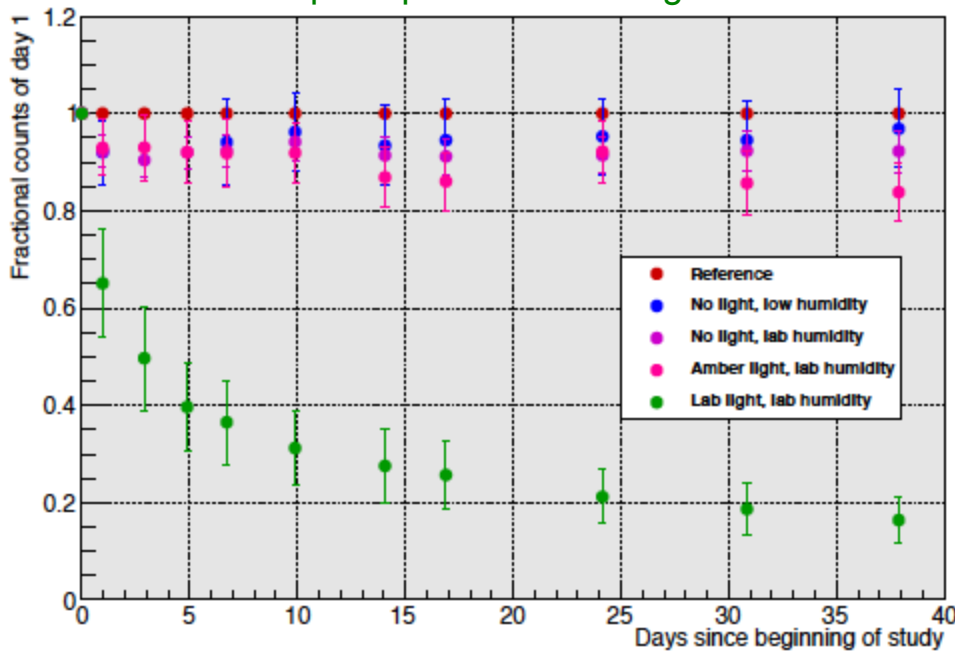

Chiu et al., JINST7(2012)P07007

Benzophenone production

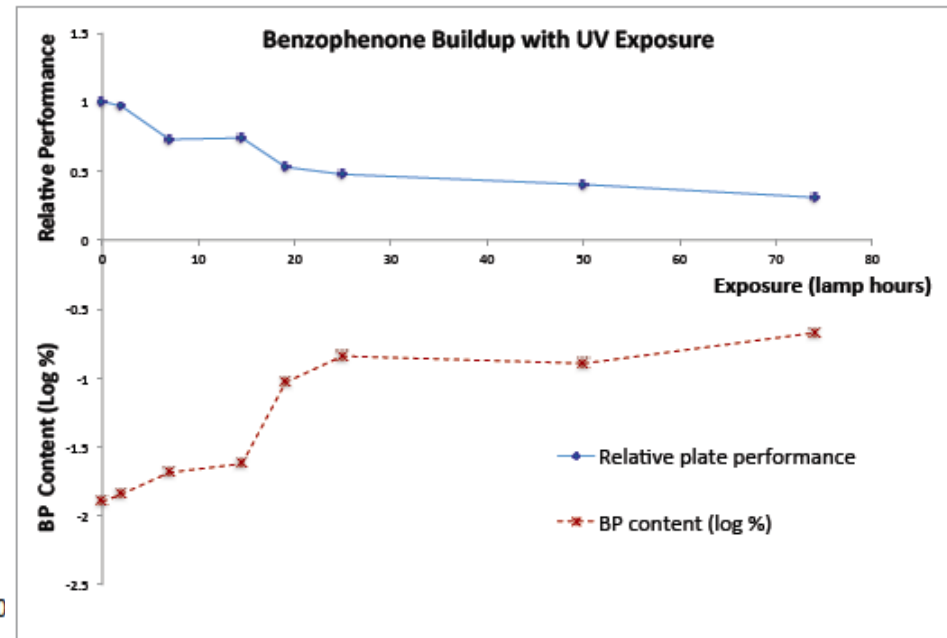

Jones et al., JINST8(2013)P01013

3. Scintillation light from argon

TPB plate idea

- deposit TPB-polystyrene mixture on acrylic plate (TPB plate)
- equip TPB in front of PMT

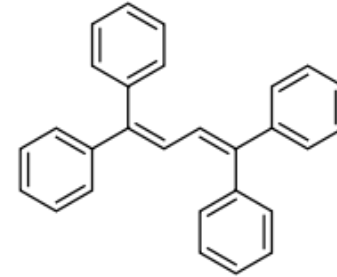

Mechanical model of
MicroBooNE PMT

TPB plate sample

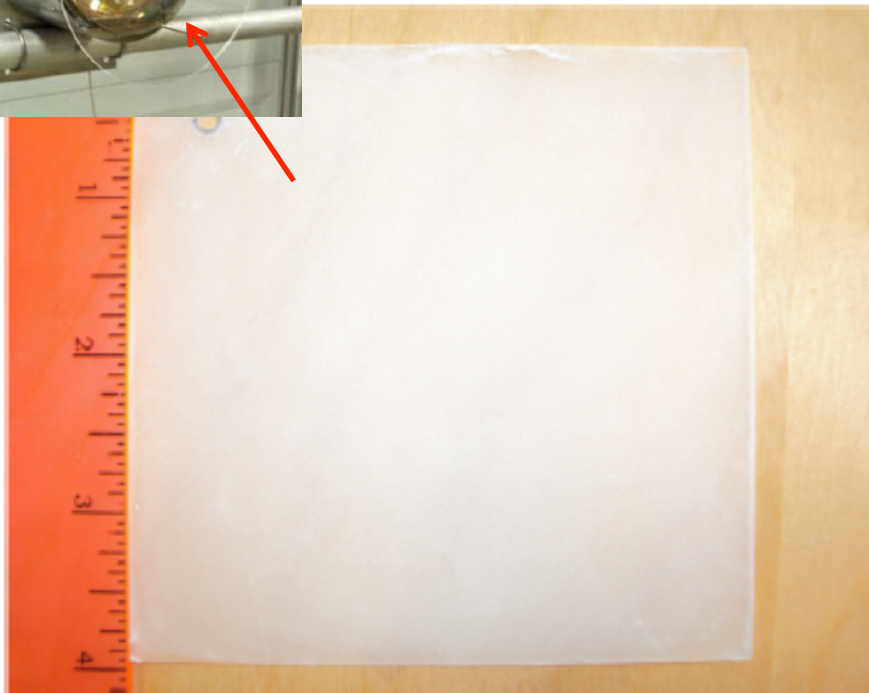

Lab6 scintillation building

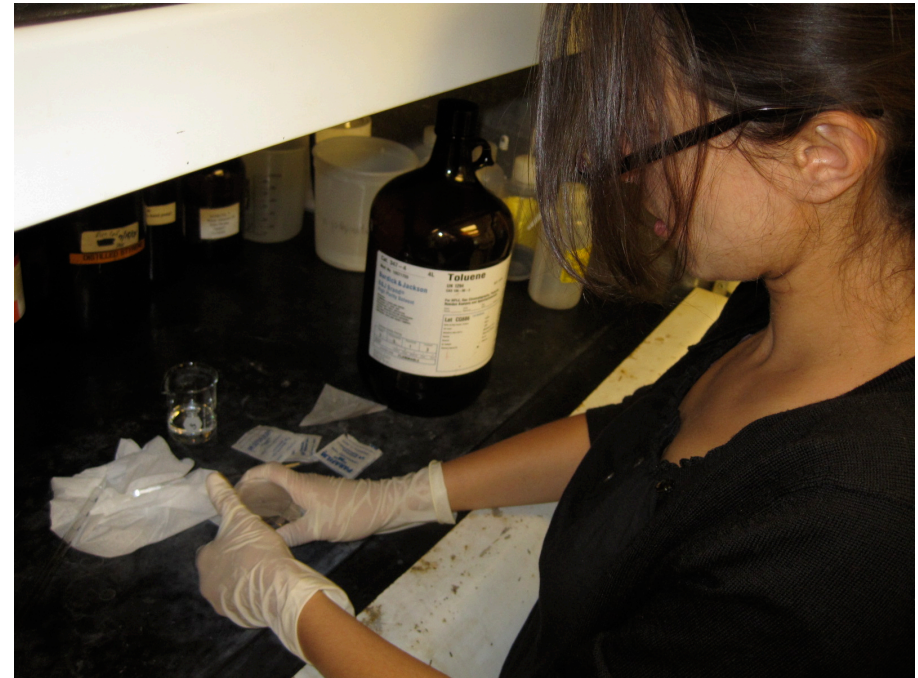

3. Scintillation light from argon

TPB plate idea

- deposit TPB-polystyrene mixture on acrylic plate (TPB plate)
 - equip TPB in front of PMT
 - performance of TPB plate is measured by vacuum spectrometer.
- Comparing with vacuum evaporated plate, it is ~OK

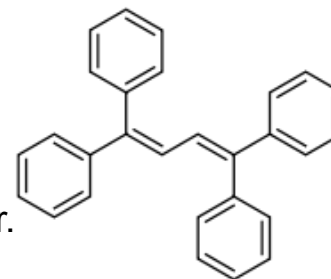

Deuterium lamp spectrum

Fermilab vacuum spectrometer

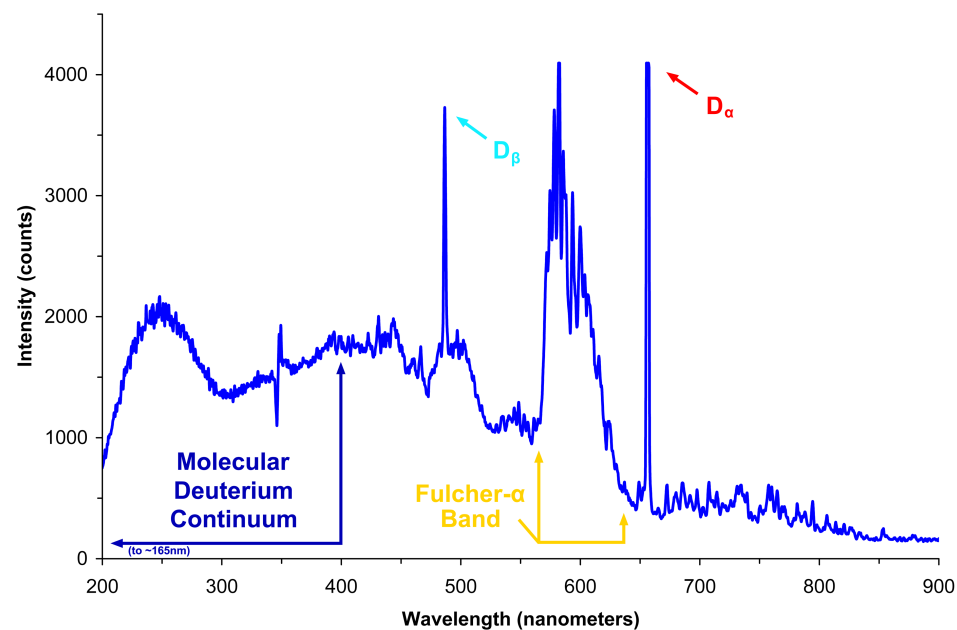
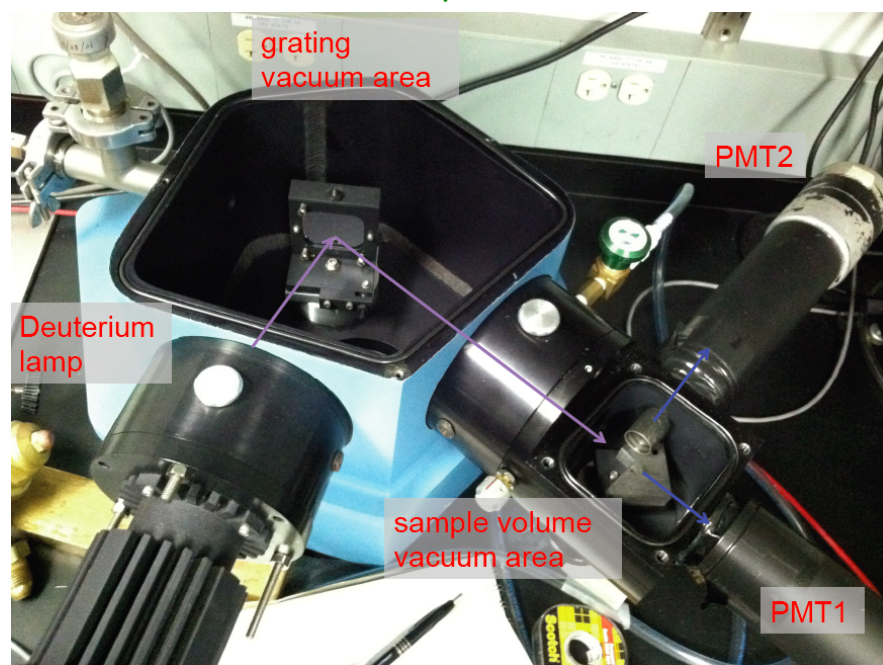

3. Scintillation light from argon

TPB plate idea

- deposit TPB-polystyrene mixture on acrylic plate (TPB plate)
 - equip TPB in front of PMT
 - performance of TPB plate is measured by vacuum spectrometer.
- Comparing with vacuum evaporated plate, it is ~OK

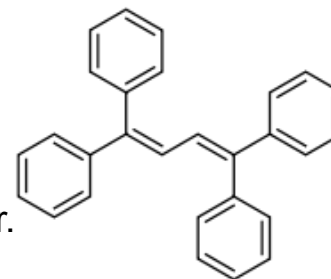

Fermilab vacuum spectrometer

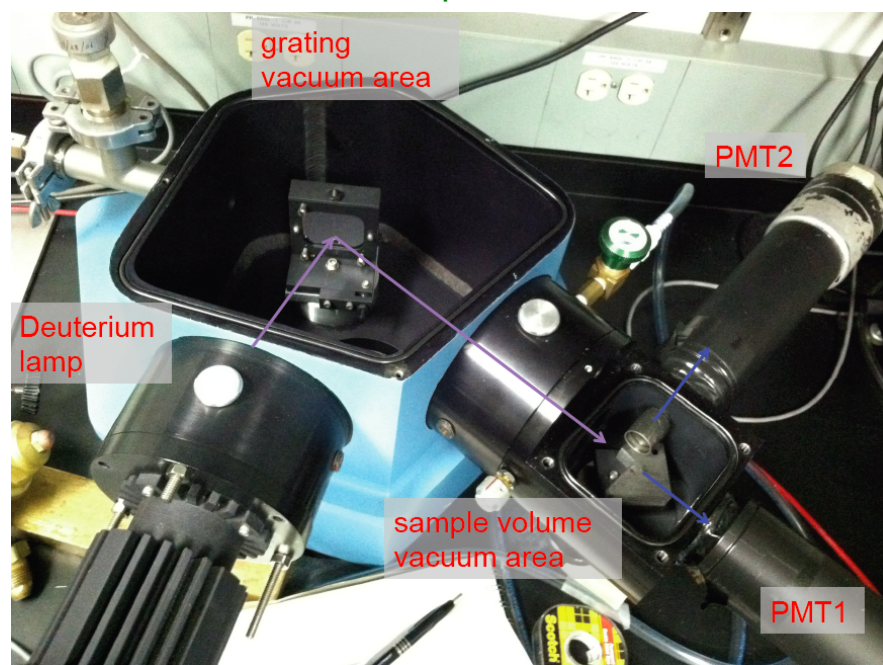

TPB plate performance

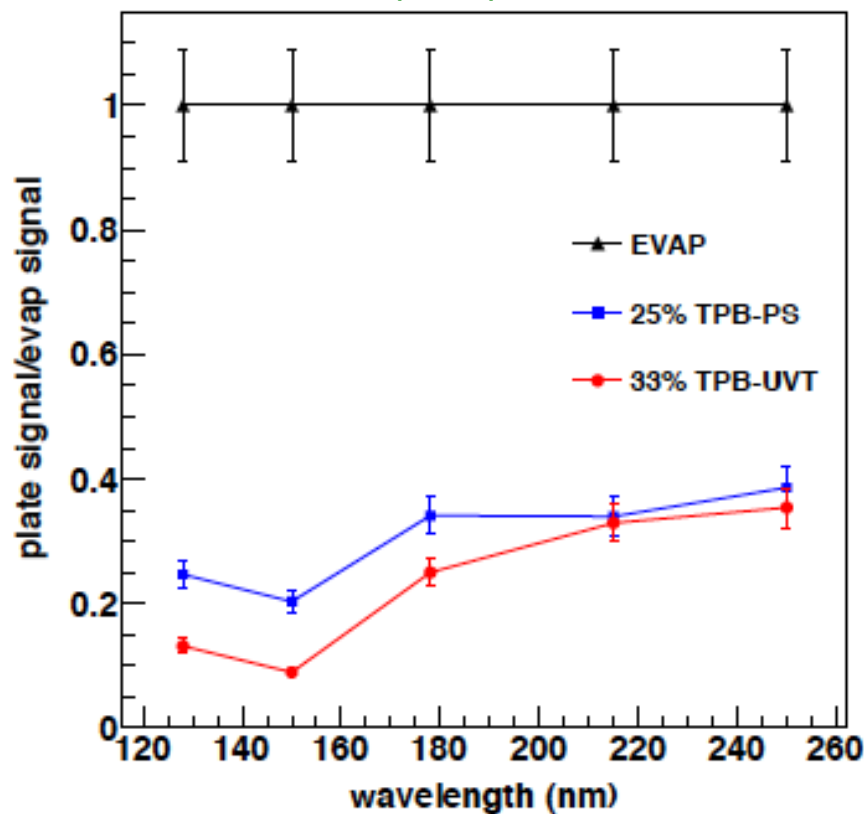

3. Scintillation light from argon

Impurity measurement

- O_2 and N_2 are known impurity to reduce scintillation output
- Nitrogen is not controlled in LArTPC experiment (oxygen is <ppb to make TPC works)
- Nitrogen injection line and monitor is installed in Bo cryostat system

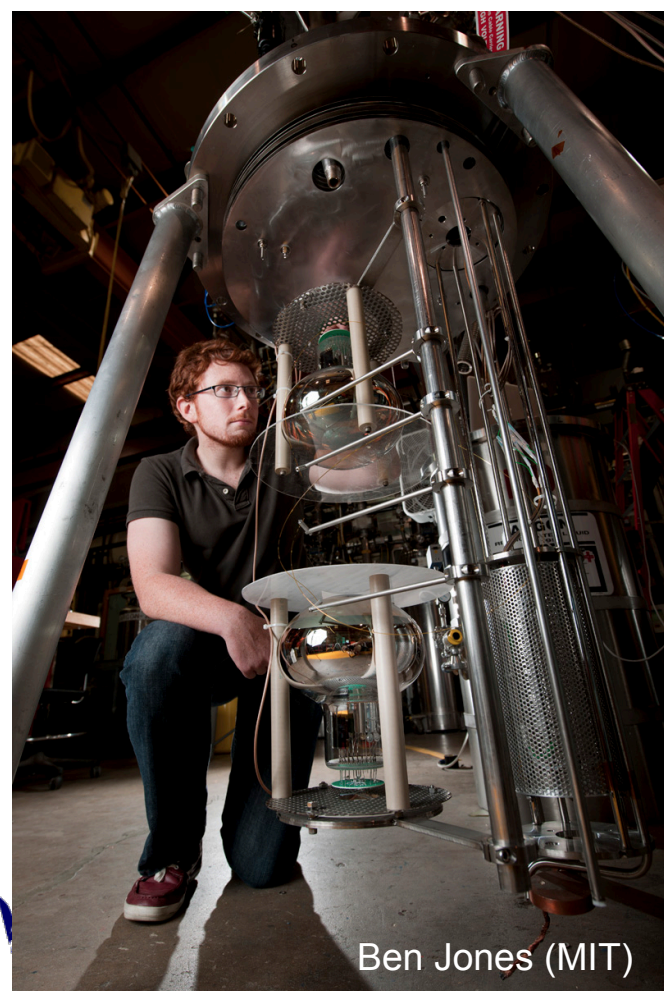

Ben Jones (MIT)

University of London

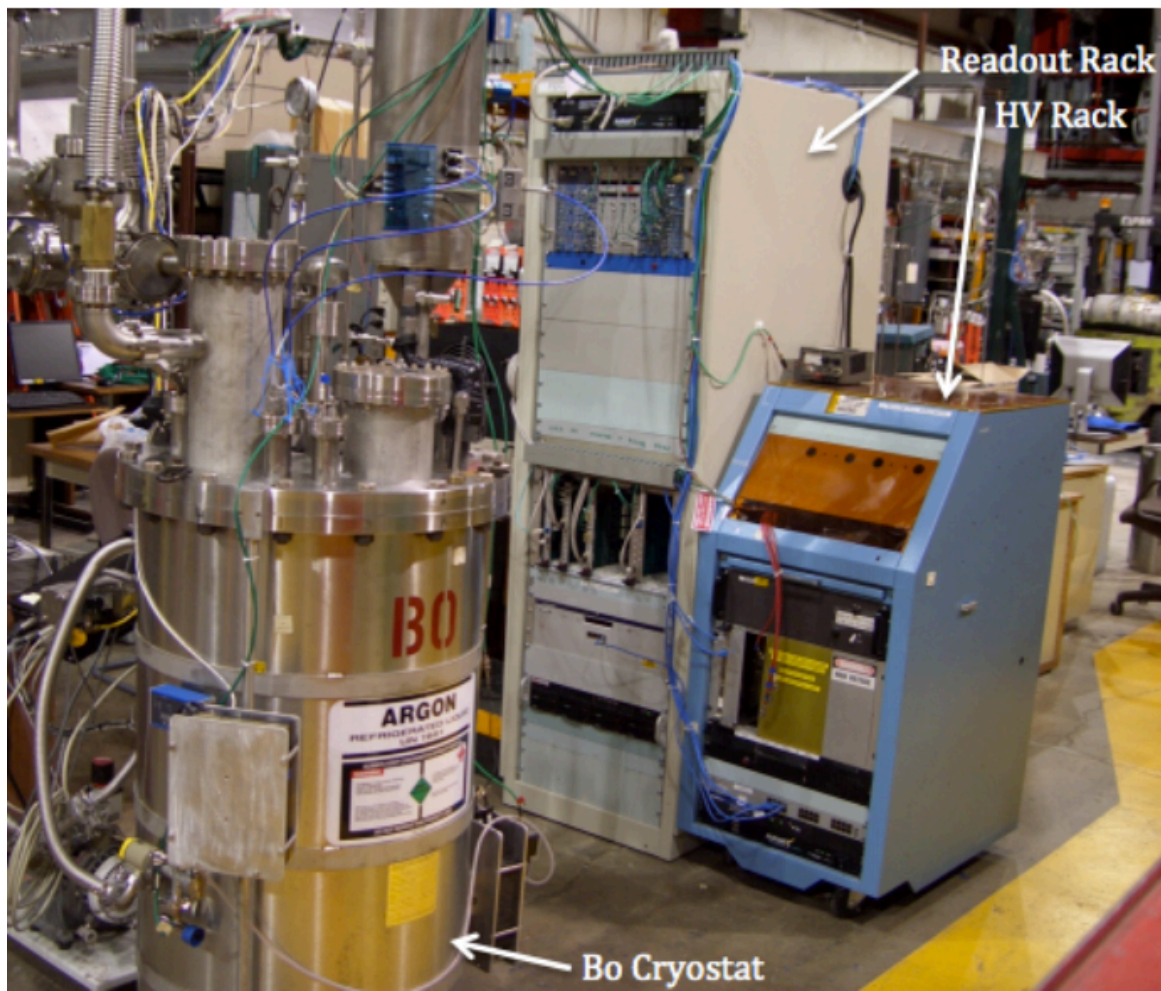

Bo Cryostat

3. Scintillation light from argon

Impurity measurement

- O₂ and N₂ are known impurity to reduce scintillation output
- Nitrogen is not controlled in LArTPC experiment (oxygen is <ppb to make TPC works)
- Nitrogen injection line and monitor is installed in Bo cryostat system



Ben Jones (MIT)

University of London

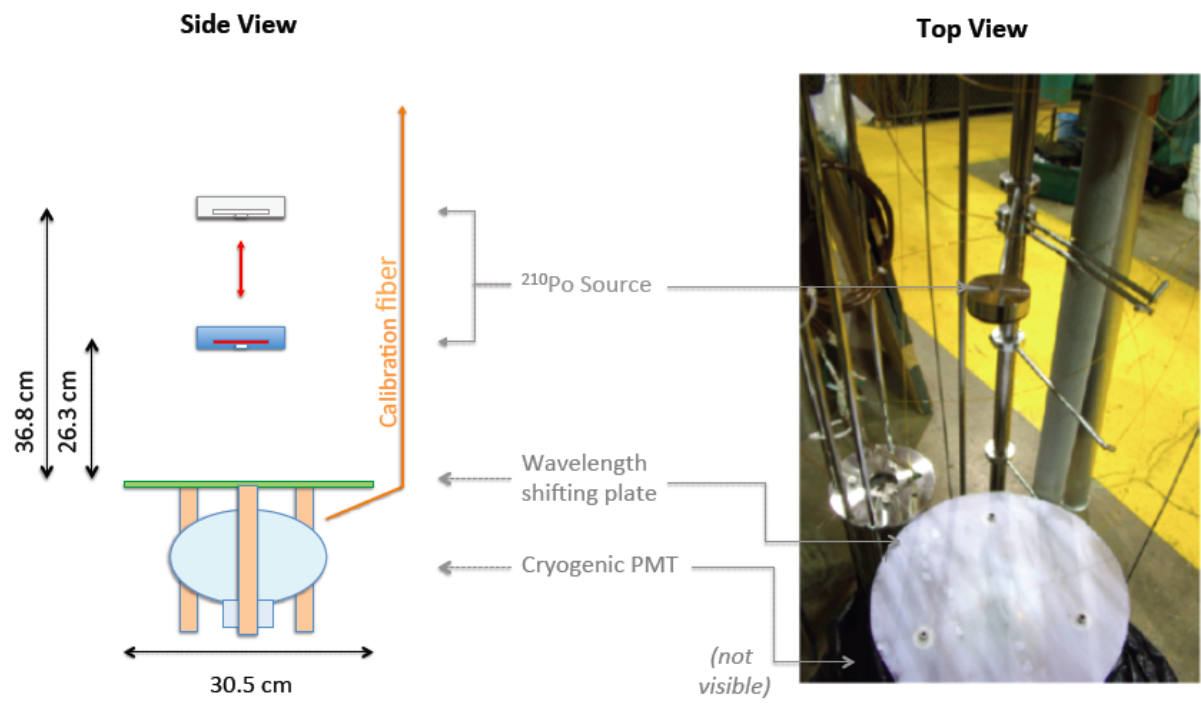

Tepei Katori

02/19/14

3. Scintillation light from argon

Impurity measurement

- O_2 and N_2 are known impurity to reduce scintillation output
- Nitrogen is not controlled in LArTPC experiment (oxygen is <ppb to make TPC works)
- Nitrogen injection line and monitor is installed in Bo cryostat system
- LAr with “typical” N_2 impurity has negligible effect on attenuation

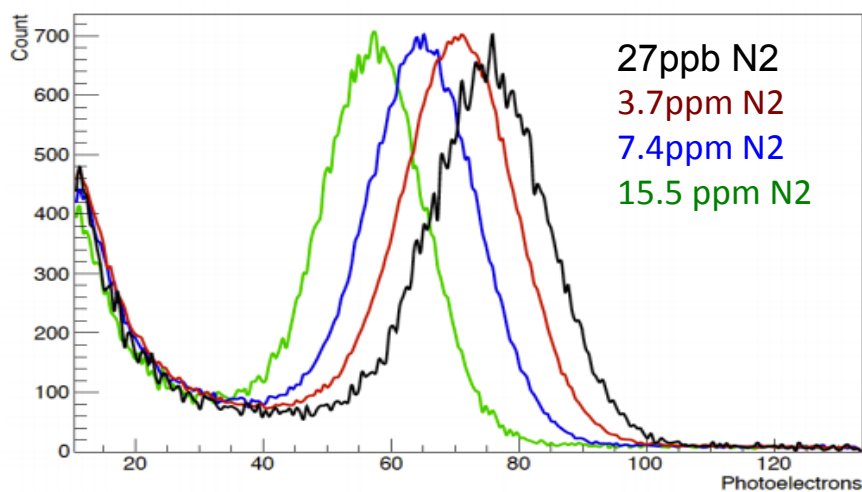

Light output from ^{210}Po

Argon Specification	Concentration of N_2	Absorption Length
Measured N_2 concentration of clean argon for this study	37 ppb	1790 ± 160 m
AirGas research (grade 6) argon [25]	1 ppm	66 ± 6 m
MicroBooNE cryogenic specification	2 ppm	30 ± 3 m
Start of liquid recirculation phase of Liquid Argon Purity Demonstrator, Run 2 [26, 27]	8 ppm	8.2 ± 0.7 m
AirGas industrial (grade 4) argon [25]	100 ppm	0.65 ± 0.06 m

3. Scintillation light from argon

Cryogenic PMT

- bi-alkali photo-cathode stops working at $\sim 150\text{K}$
- Pt-coating to save electron mobility (1st generation cryogenic PMT)
 - slight loss of quantum efficiency
- super bi-alkali works in cold (2nd generation cryogenic PMT)
- base circuit should avoid temperature dependent components
- heat deposit $\sim 0.5\text{W}/\text{base}$

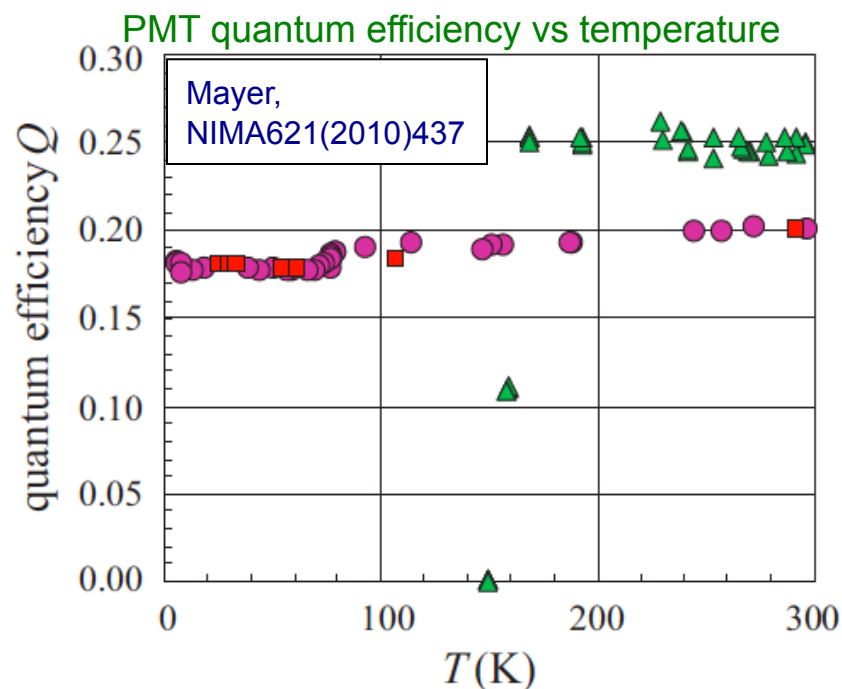

MicroBooNE PMT base

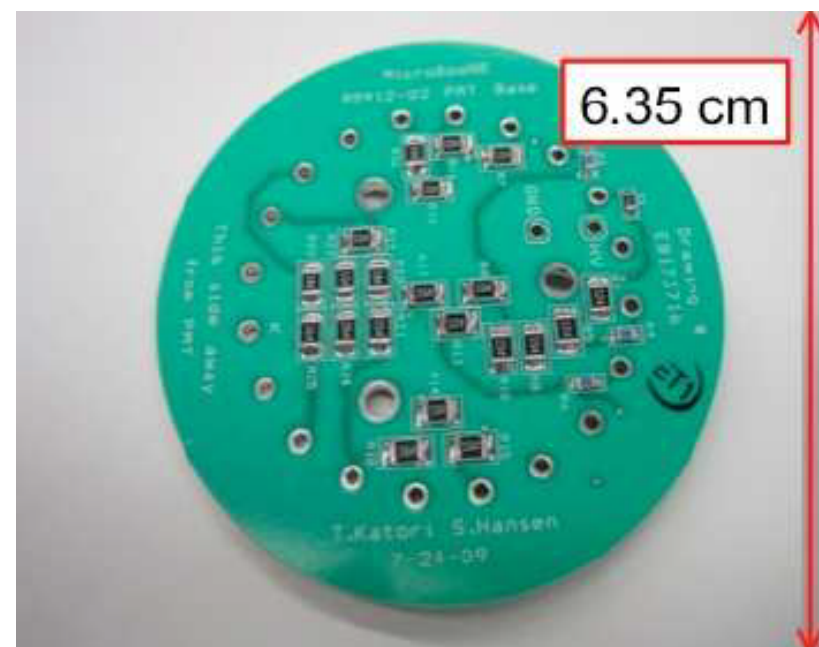

3. MicroBooNE PMT test stand

Open Dewar based PMT test stand

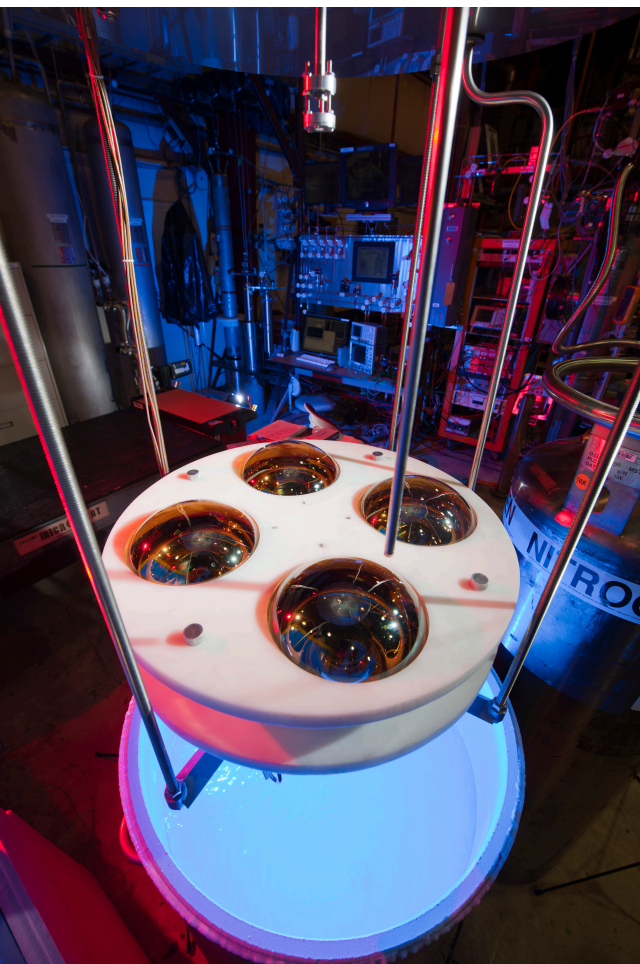

PMT TEST STAND

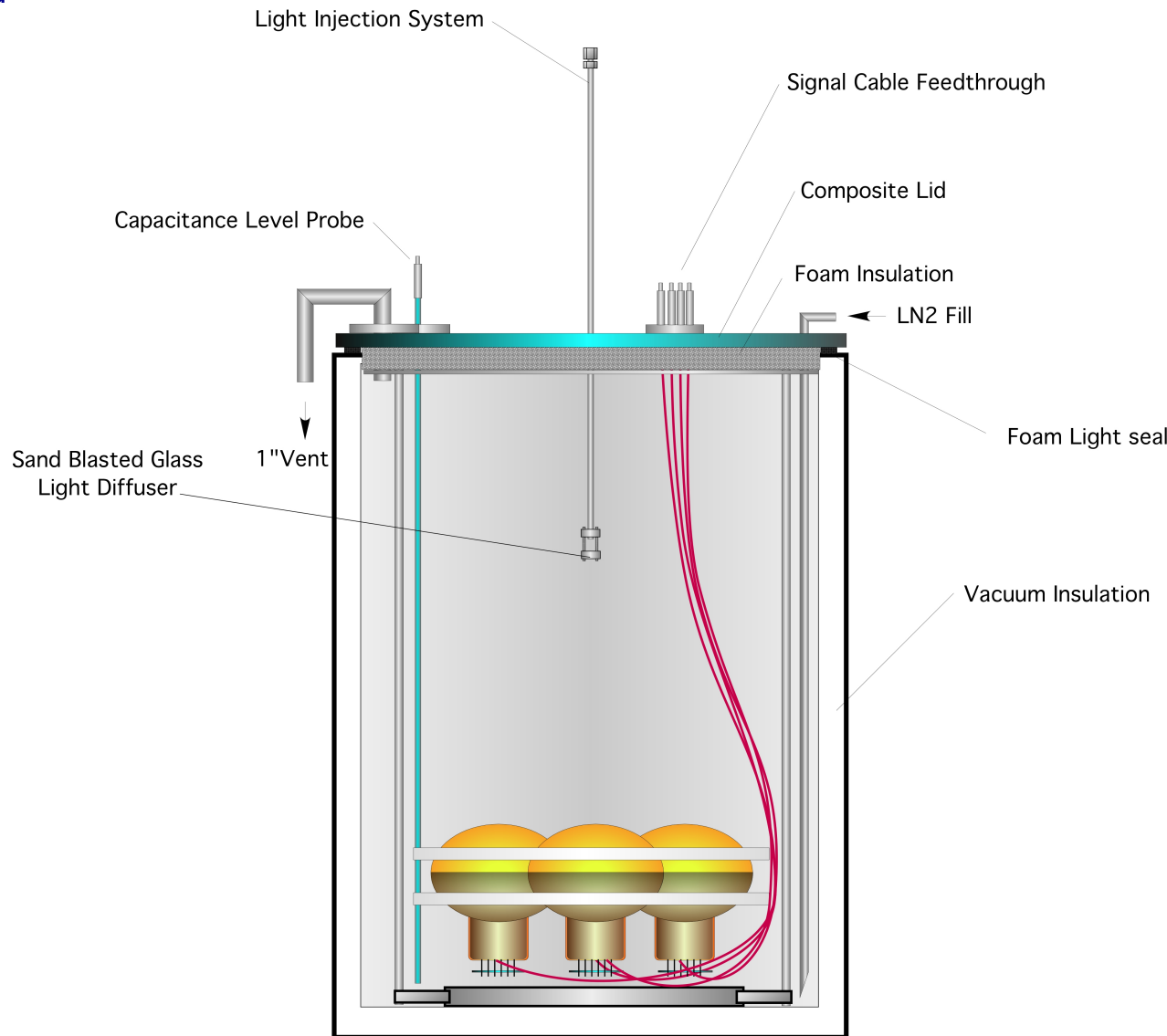

3. MicroBooNE PMT test stand

Open Dewar based PMT test stand

- All structures are attached on glass fiber lid
- there are 5 penetrations
 - LN2 injection
 - gas vent
 - level sensor
 - cable feed-through
 - light injection system
- In room temperature, PMTs sit on Delrin bottom fixture
- In LN2, PMTs float and fit in Delrin upper fixture
- There is a weight at the bottom of the structure

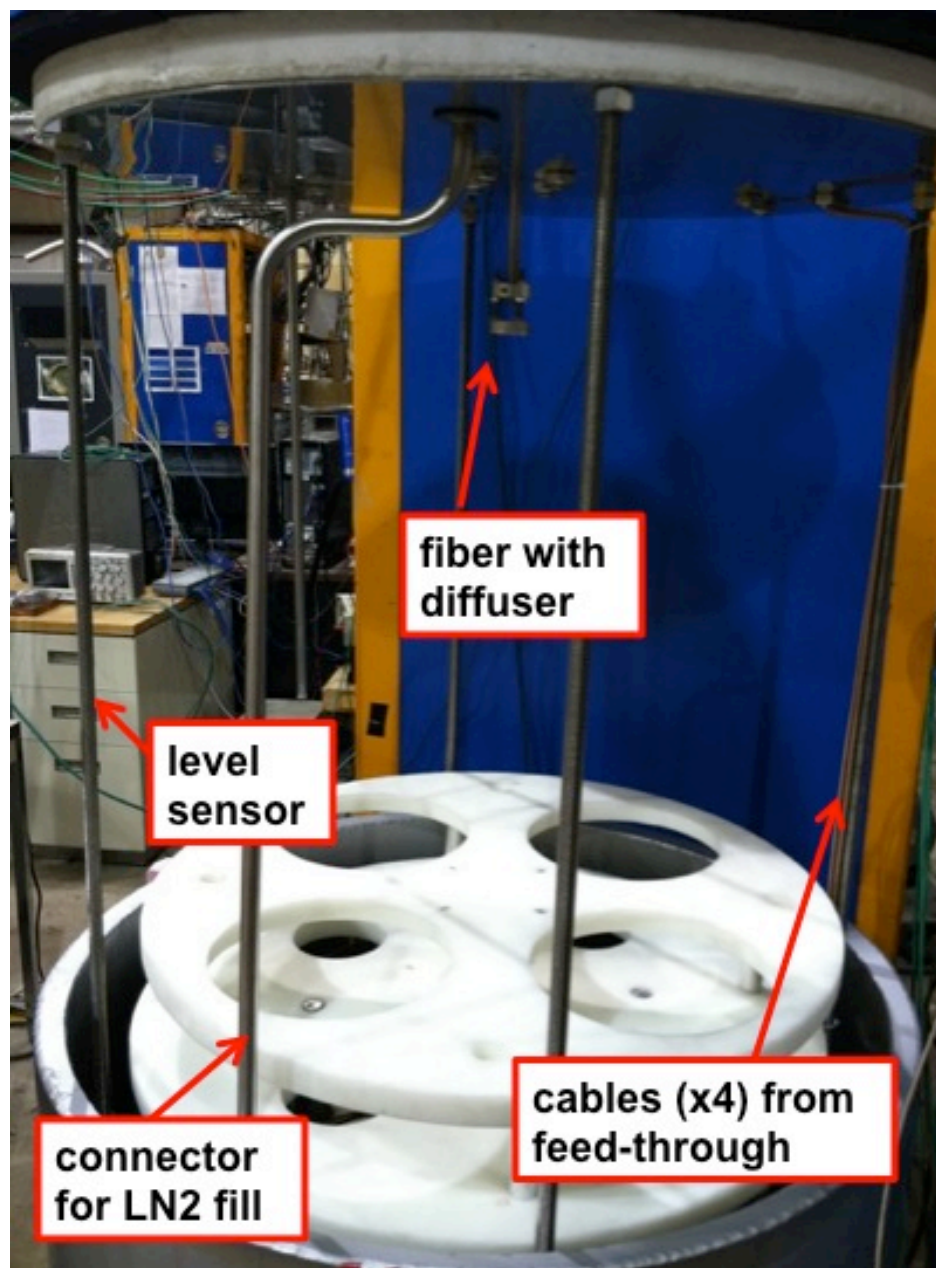
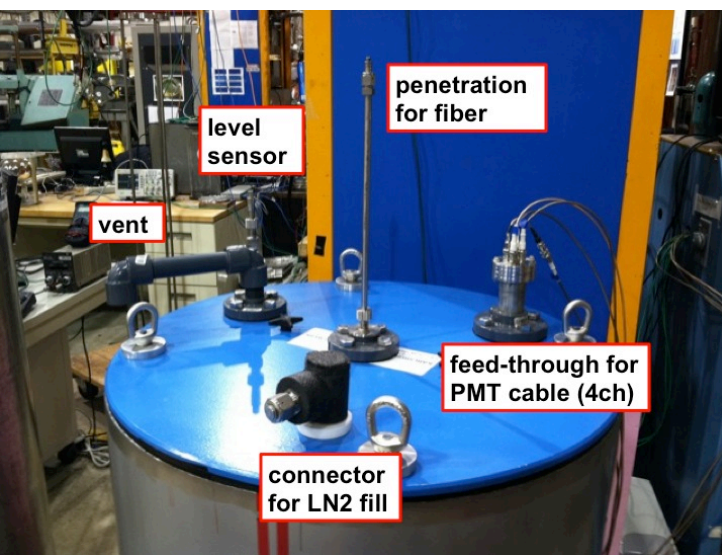

3. MicroBooNE PMT test stand

Open Dewar based PMT test stand

Purpose

- All PMTs need to be operated in cryogenic temperature before the experiment
- Verify spec gain and dark current in cryogenic condition
- Gain experiences of cryogenic PMT operation
- Study basic features (how long do you need to cool down, etc)

No need to be pressurized vessel (expensive, safety issue)

Large open Dewar with modification

- commercial open Dewar, 346L (70cmx90cm inner diameter and height), \$17,000
- Labor + Materials ~ \$5000
- Total \$22,000
- Need 1 or 2 of 160L LN2 bottle to fill every week (LN2~\$30, LAr~\$160)
- No need technician's help for operation

Test procedure

- 4 PMTs are simultaneously immersed in LN2
- 1 PMT (calibration PMT) stays same location during all tests
- PMTs are immersed in LN2 least 3 days with dark before any tests
- LED illumination + trigger in LN2 (no purity issue)

3. MicroBooNE PMT test stand

Open Dewar based PMT test stand

- Dark current and gain are measured both in air and liquid nitrogen (LN2).
- Operation HV values in cryogenic temperature are extracted.

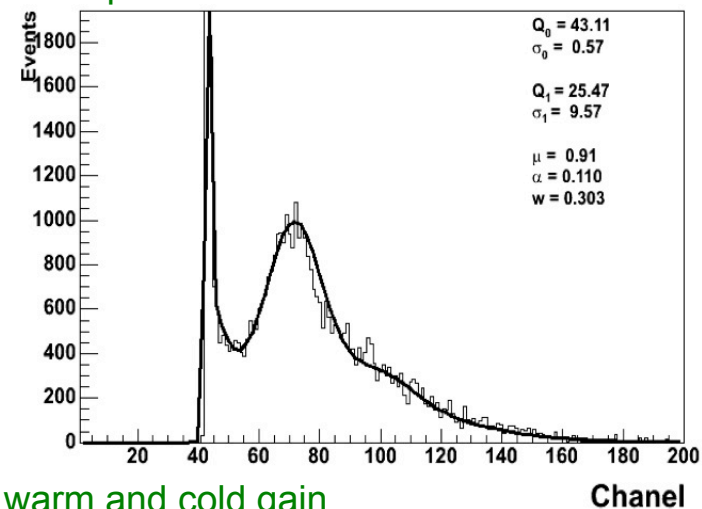

Typical warm and cold gain

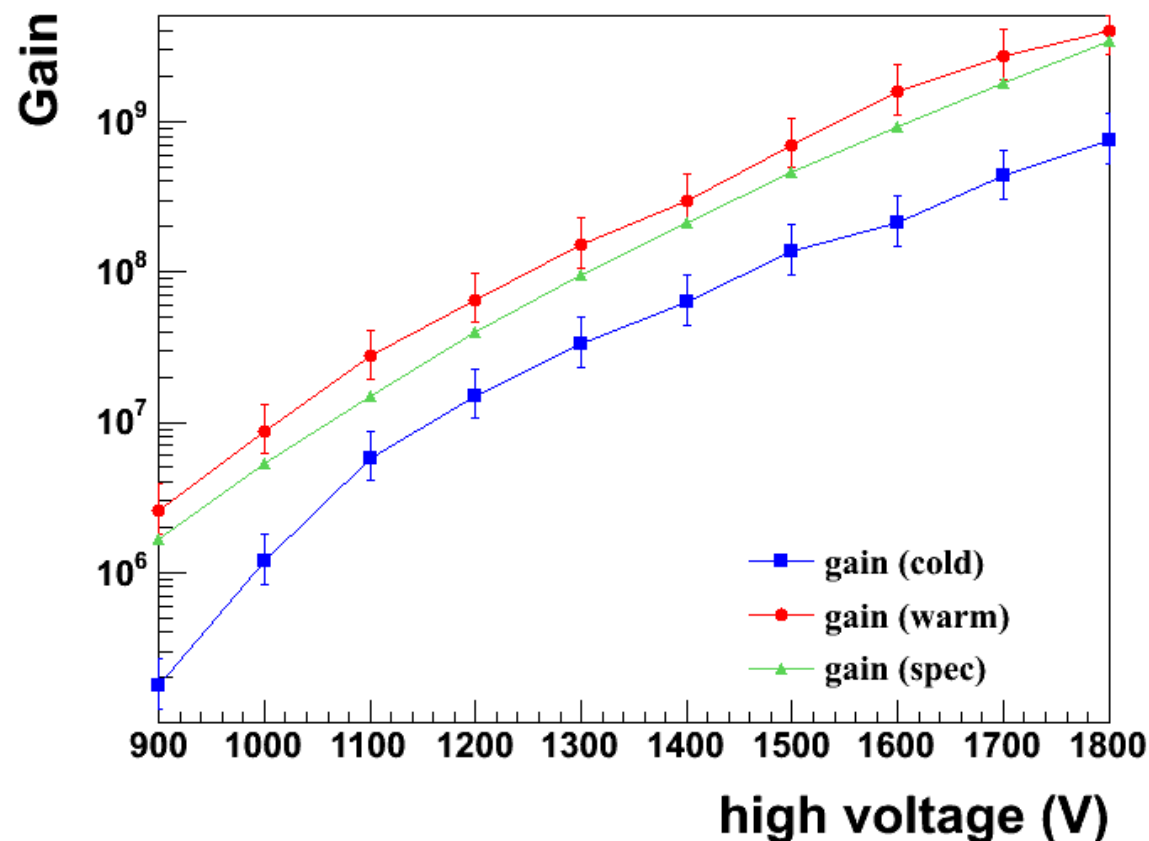

Gains are measured at every 100V from 900V to 1800V.

PMT cold gains are ~10-50% of warm gains.

Optimal HV value for $3E7$ gain is extrapolated.

3. MicroBooNE PMT test stand

Open Dewar based PMT test stand

- Dark current and gain are measured both in air and liquid nitrogen (LN2).
- Operation HV values in cryogenic temperature are extracted.

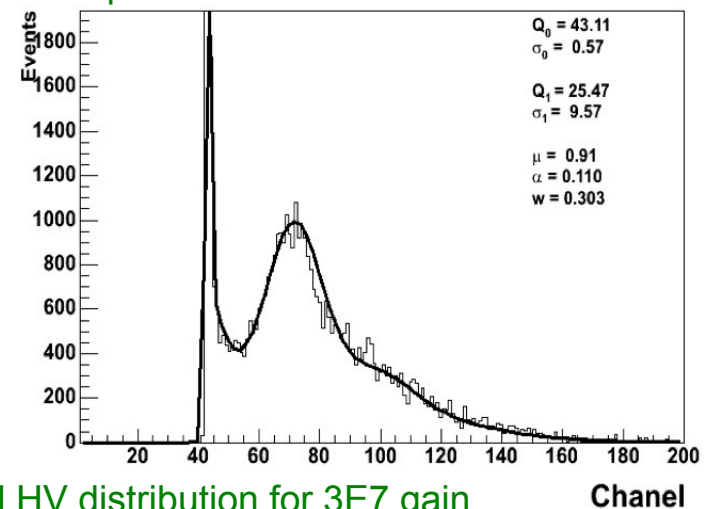

Optimal HV distribution for 3E7 gain

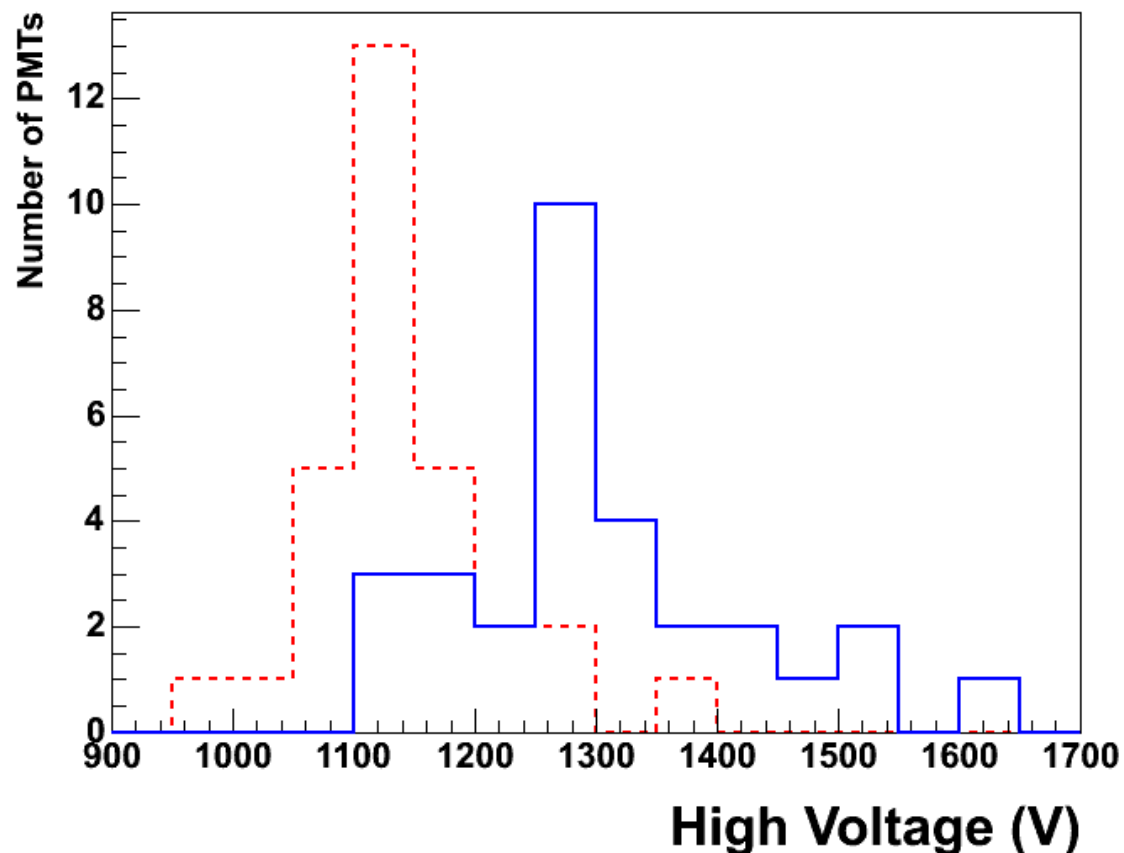

Gains are measured at every 100V from 900V to 1800V.

PMT cold gains are ~10-50% of warm gains.

Optimal HV value for 3E7 gain is extrapolated.

~200 V increase can recover gain drop

3. MicroBooNE PMT test stand

Open Dewar based PMT test stand

- Dark current and gain are measured both in air and liquid nitrogen (LN2).
- Operation HV values in cryogenic temperature are extracted.

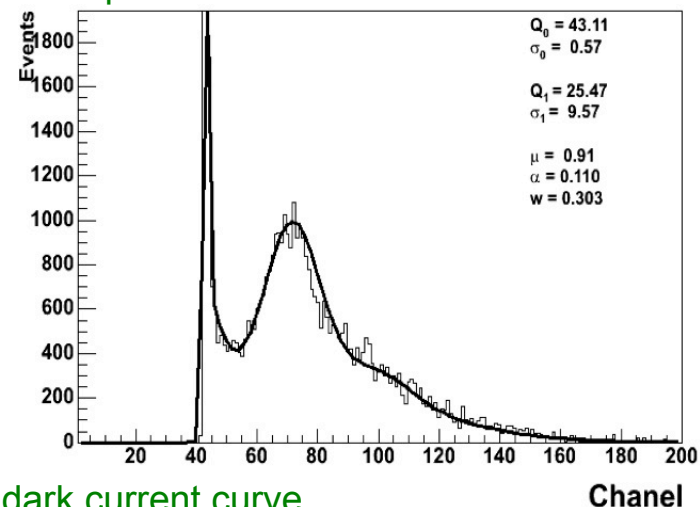

Cold dark current is slightly higher than warm dark current.

Cold noise doesn't show "plateau break down" at higher HV.

These results are not intuitive, but in fact well known.

NIMA621(2010)437

JINST2(2007)P11004

ArXiv:0805.0771

Typical dark current curve

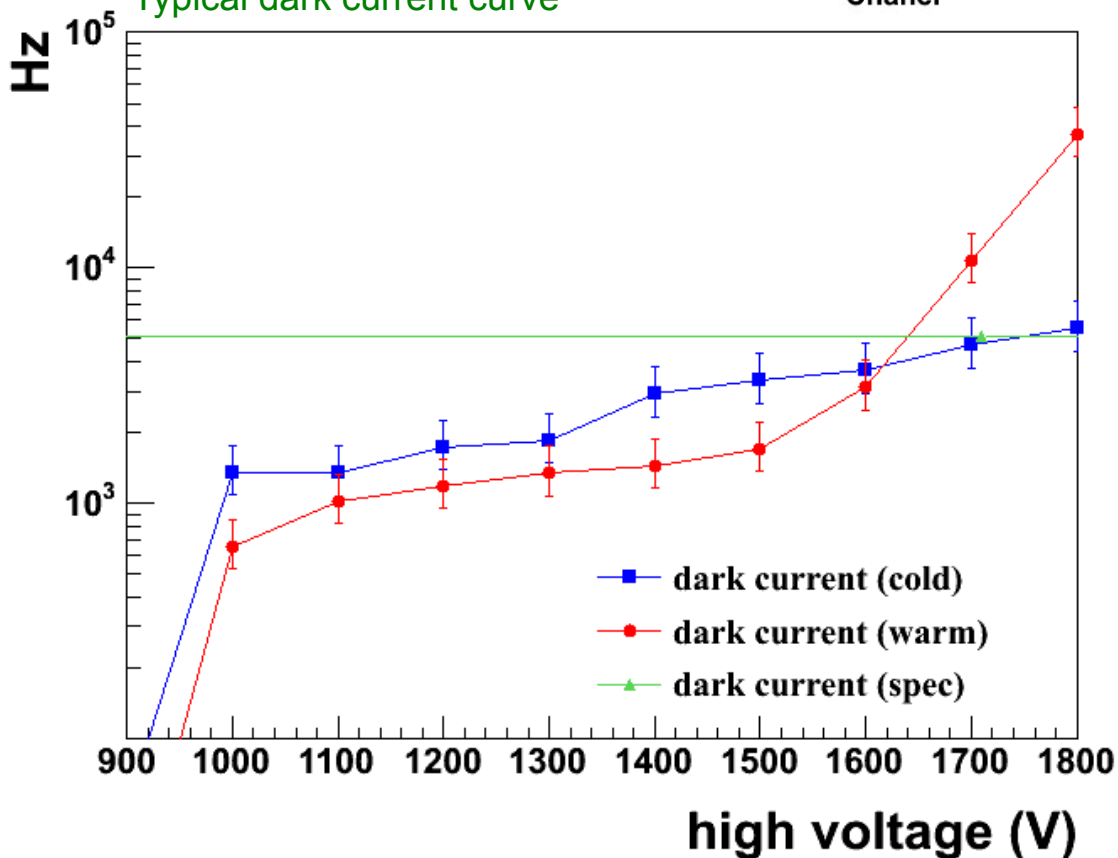

3. MicroBooNE PMT unit

32 PMTs with 4 light guides

- PMT sits in spring-loaded structure
- avoid direct glass-metal contact by teflon
- cryogenic magnetic shield

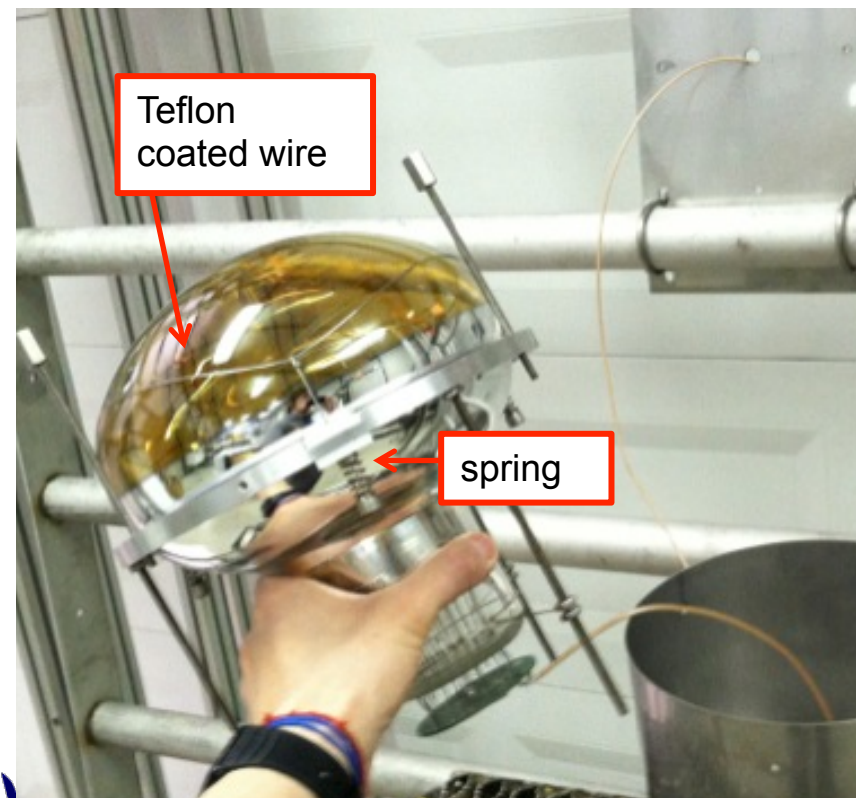
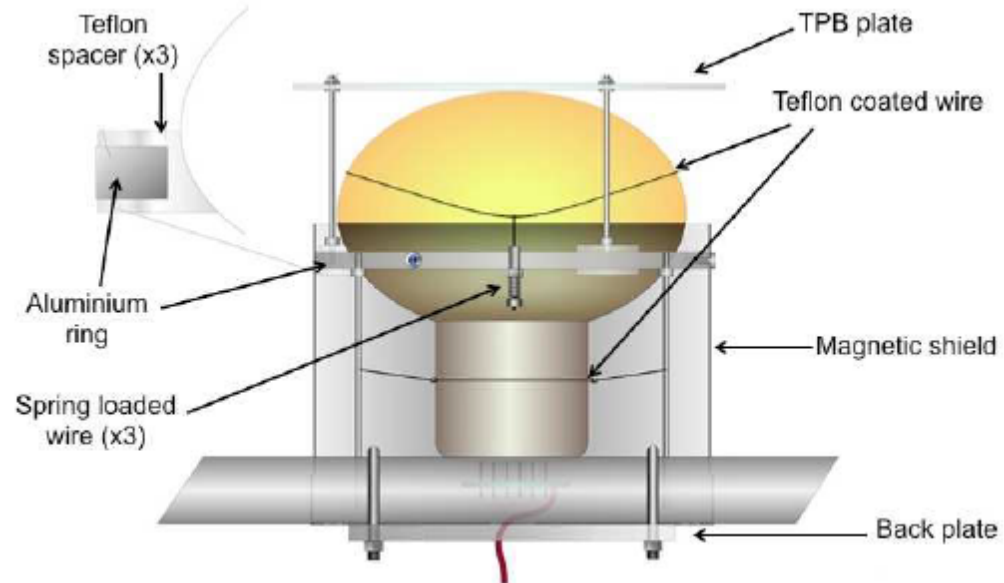

3. MicroBooNE PMT unit

32 PMTs with 4 light guides

- PMT sits in spring-loaded structure
- avoid direct glass-metal contact by teflon
- cryogenic magnetic shield

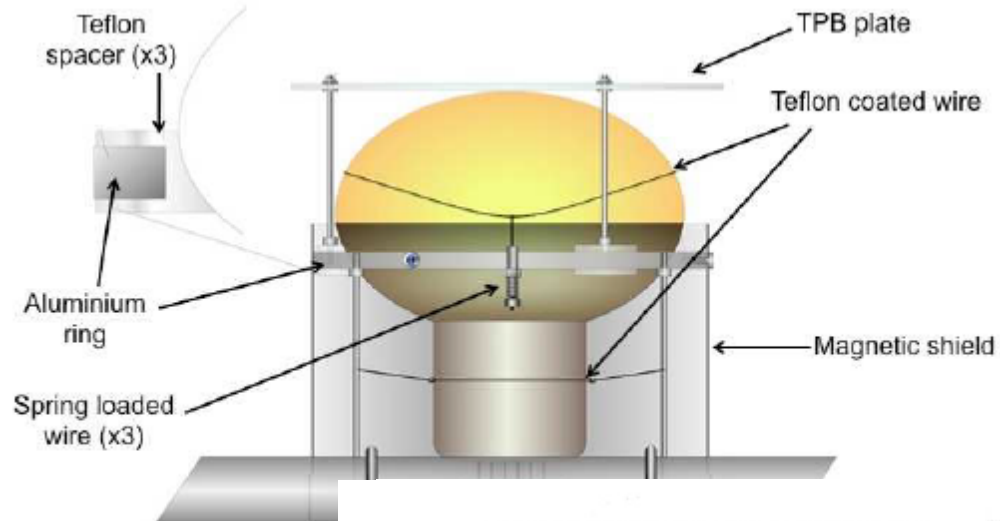

MicriBooNE PMT rotator

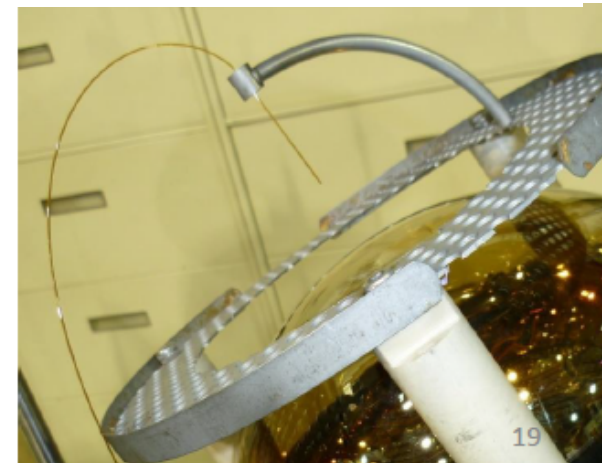
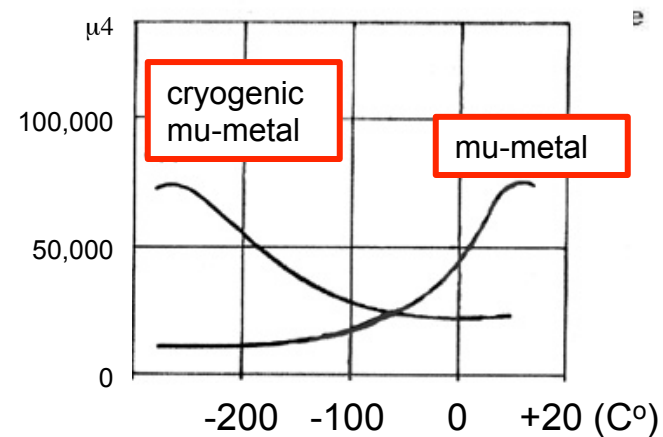
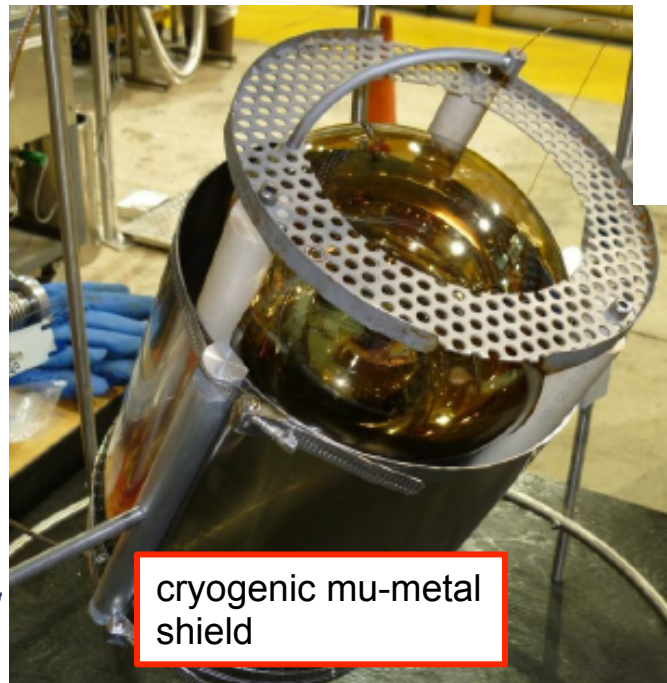
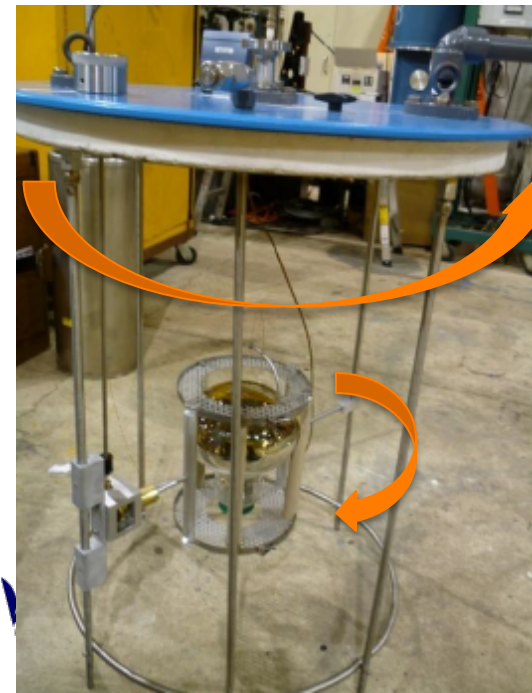

3. MicroBooNE PMT unit

32 PMTs with 4 light guides

- PMT sits in spring-loaded structure
- avoid direct glass-metal contact by teflon
- cryogenic magnetic shield

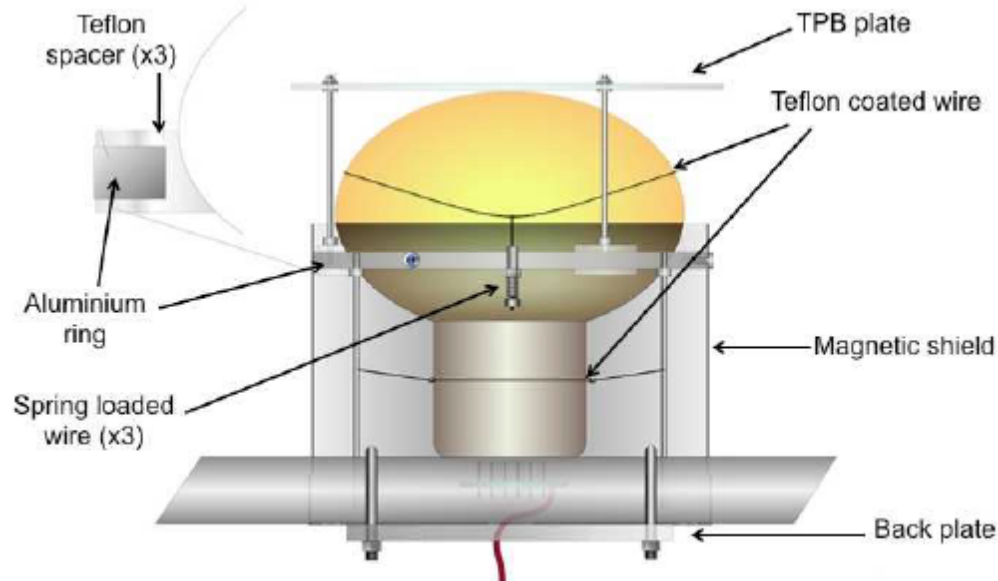
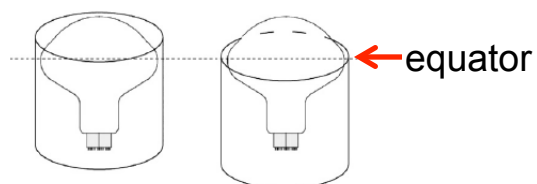

fractional deviation from mean Q vs. angle, liquid nitrogen

Relative signal variation with PMT angle

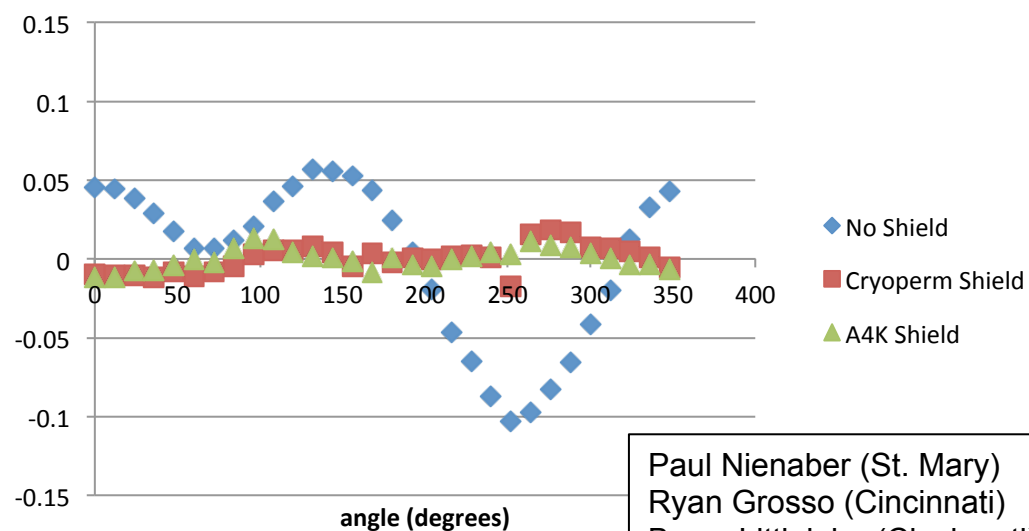
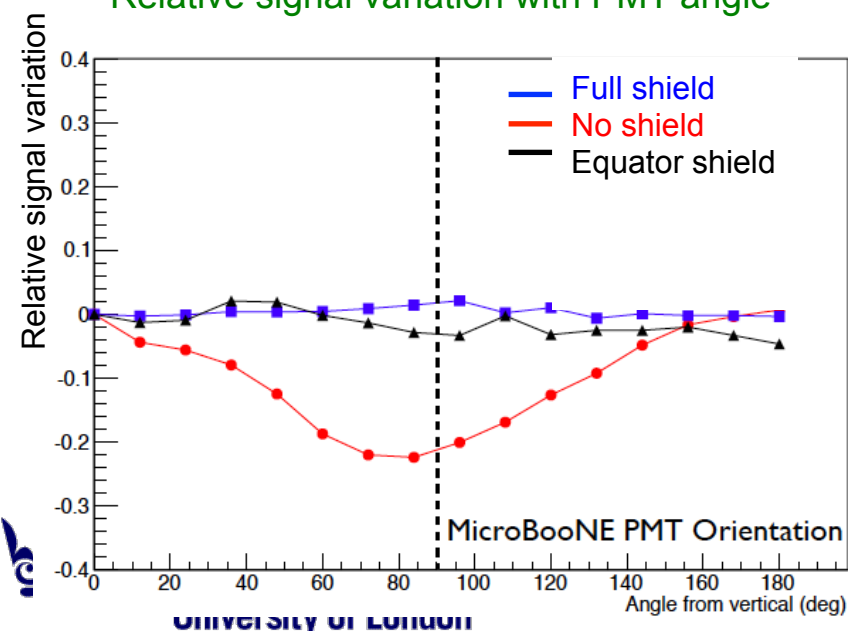

Paul Nienaber (St. Mary)
Ryan Grosso (Cincinnati)
Bryce Littlejohn (Cincinnati)

3. MicroBooNE PMT array system

32 PMTs with 4 light guides

- PMT sits in spring-loaded structure
- avoid direct glass-metal contact by teflon
- cryogenic magnetic shield

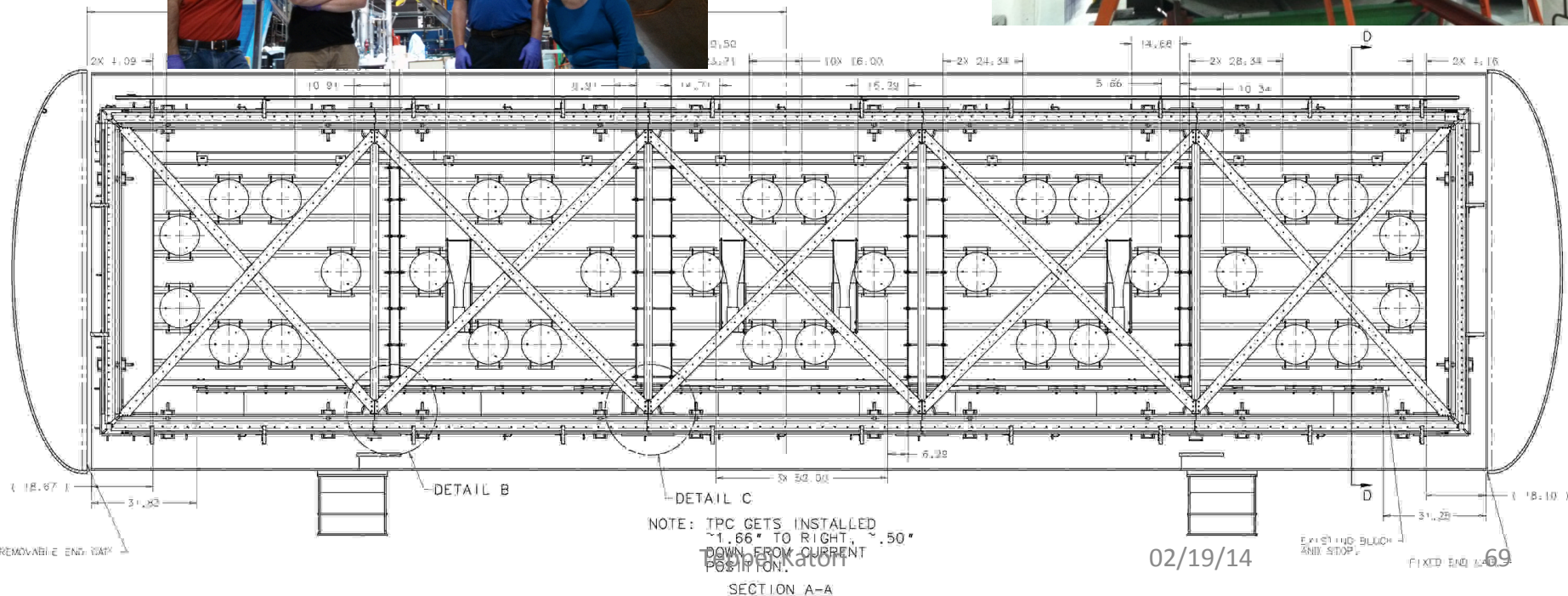
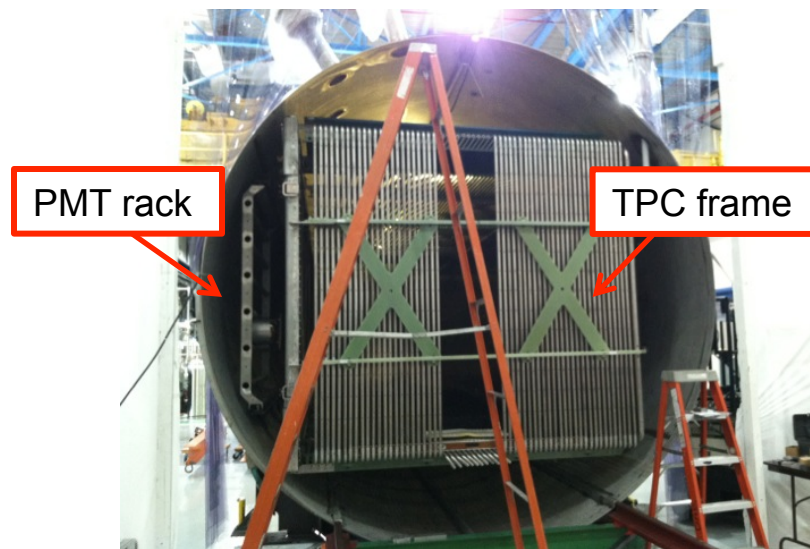

3. Light guide

TPB coated acrylic bar

- TPB re-emitted light is trapped in acrylic bar, and internally reflect
- Collected by photo-sensor (2-inch PMT) at the end
- The concept works, efficiency seems low
- MicroBooNE has 4 of them to compare performance with 8-inch PMTs

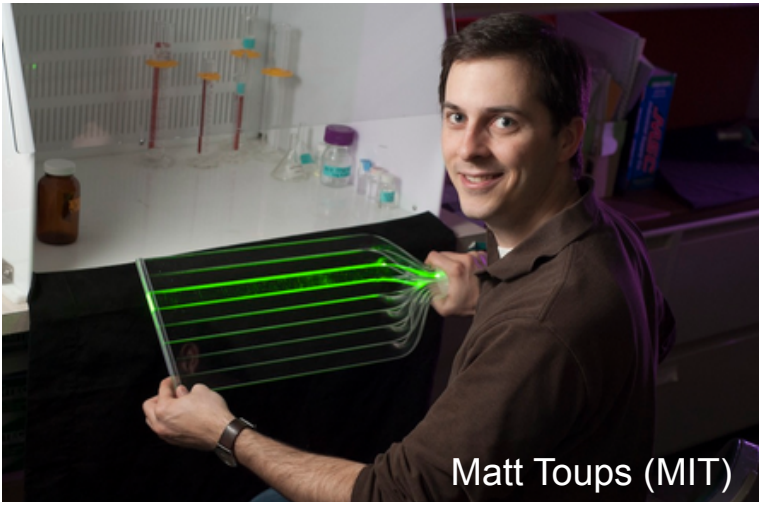

LBNE APA concept
Anode Plane Assembly
conceptual design. Wires
are wrapping around a light
guide

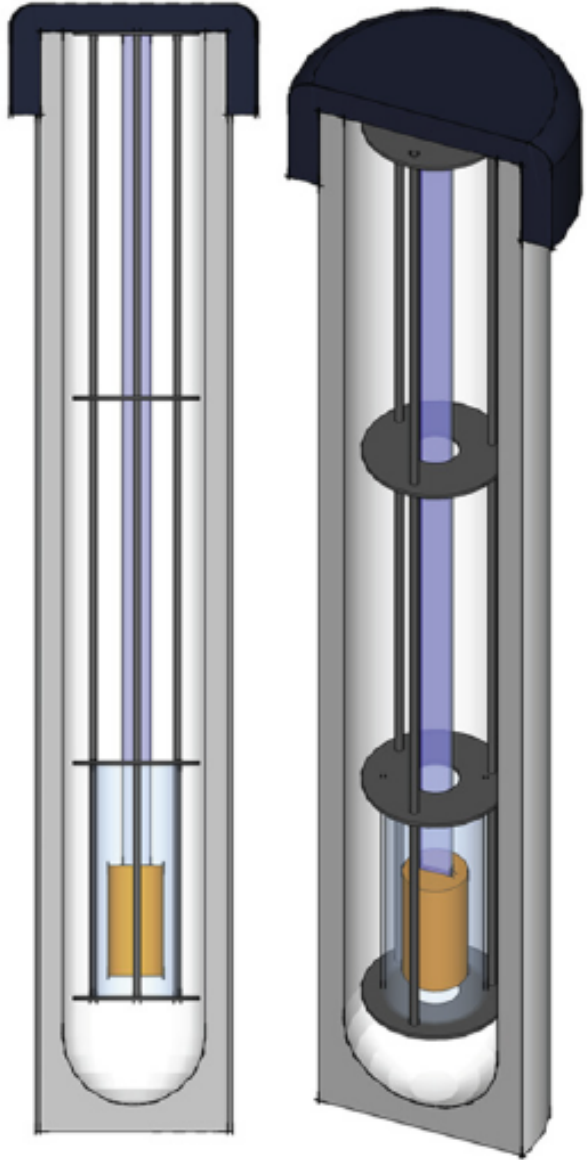
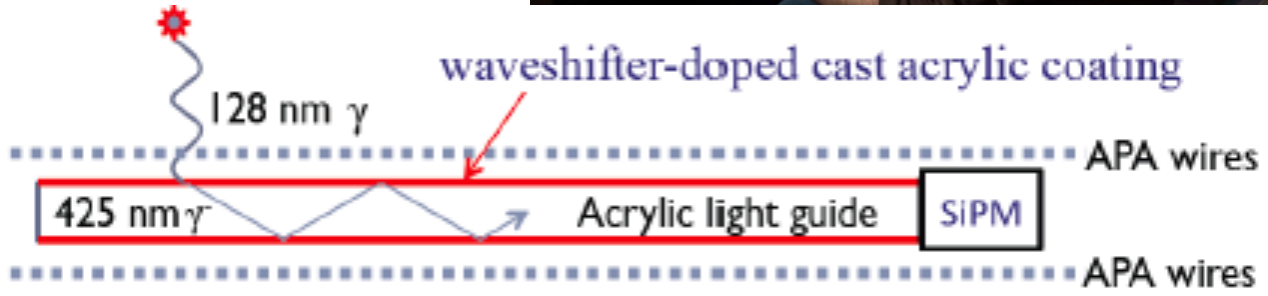

3. Light guide

TPB coated acrylic bar

- TPB re-emitted light is trapped in acrylic bar, and internally reflect
- Collected by photo-sensor (2-inch PMT) at the end
- The concept works, efficiency seems low
- MicroBooNE has 4 of them to compare performance with 8-inch PMTs

MIT test results

- The basic idea works
- Efficiency is rather low ($\sim 0.1\%$)
- Lots of room to improve
 - better quality of acrylic
 - better TPB deposition technique

Long Bo

- Indiana university further improved this technique, and tested

LBNE35ton

- It will equipped one of these

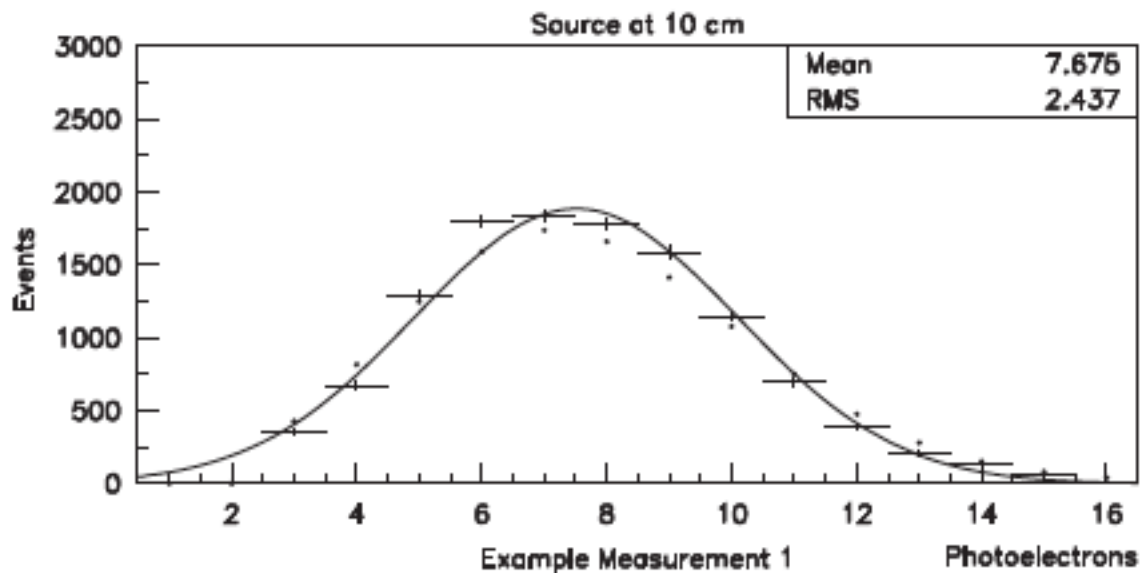

3. MIT LAr light collection group

1. The Effects of Dissolved Methane upon Liquid Argon Scintillation Light
Ben Jones et al., (JINST 8 (2013) P12015)
2. A Measurement of the Absorption of LAr Scintillation Light by Dissolved N₂ at the Part-Per-Million Level
Ben Jones et al., (JINST 8 (2013) P07011)
3. Testing of Cryogenic Photomultiplier Tubes for the MicroBooNE Experiment
Briese et al., (JINST 8 (2013) T07005)
4. Photodegradation Mechanisms of Tetraphenyl Butadiene Coatings for Liquid Argon Detectors
Ben Jones et al., (JINST 8 (2013) P01013)
5. Benchmarking TPB-coated Light Guides for Liquid Argon TPC Light Detection Systems
B. Baptista et al., (e-Print: arXiv:1210.3793 [physics.ins-det])
6. Environmental Effects on TPB Wavelength-Shifting Coatings
C. Chiu et al., (JINST 7 (2012) P07007)
7. Demonstration of a Lightguide Detector for Liquid Argon TPCs
L. Bugel et al., (Nucl.Instrum.Meth. A640 (2011) 69-75)

Liquid argon is the home of R&D papers!

1. Introduction
2. US LArTPC programs
3. LAr photon detection R&D
- 4. Challenge of LArTPC technology**
5. Conclusion

4. Challenge of LArTPC technology

Cosmic rays

- Cosmic rays of MicroBooNE is $\sim 10\text{kHz}$
- MicroBooNE DAQ windows is least 1.67ms (probably longer, if 125kV is not possible)
- ~ 20 cosmic rays across the detector in the DAQ window
- Reconstruction program needs to find true neutrino interaction and tracks successfully
- Combination of PMT and TPC information can find all cosmic rays efficiently

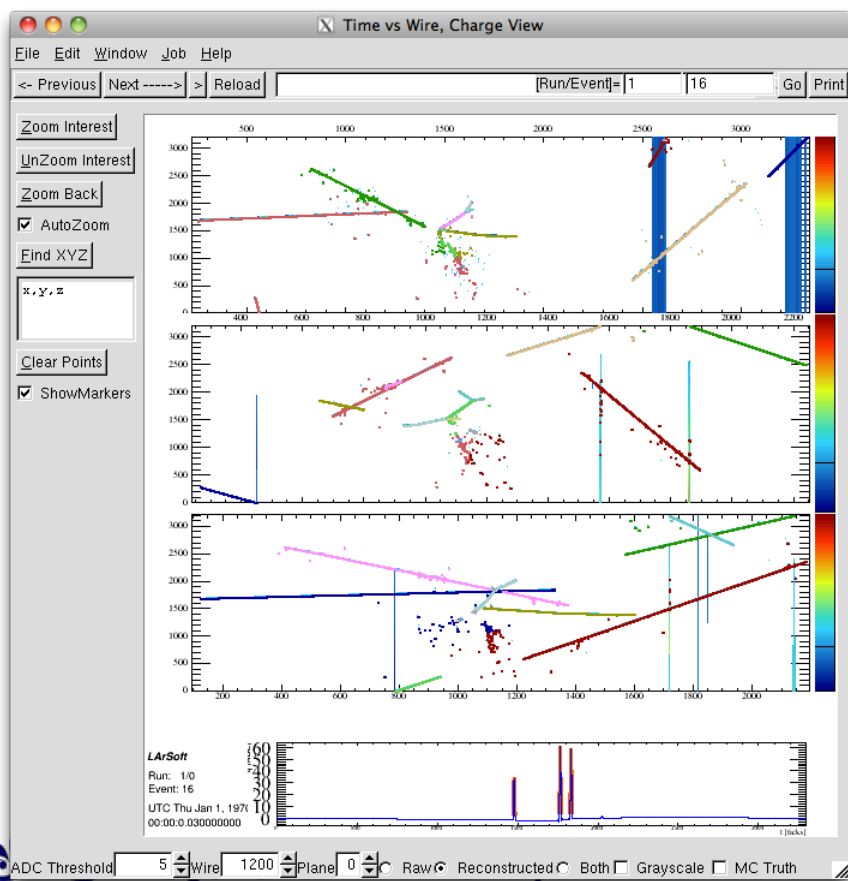

Simulated MicroBooNE event, reconstructed in 3D

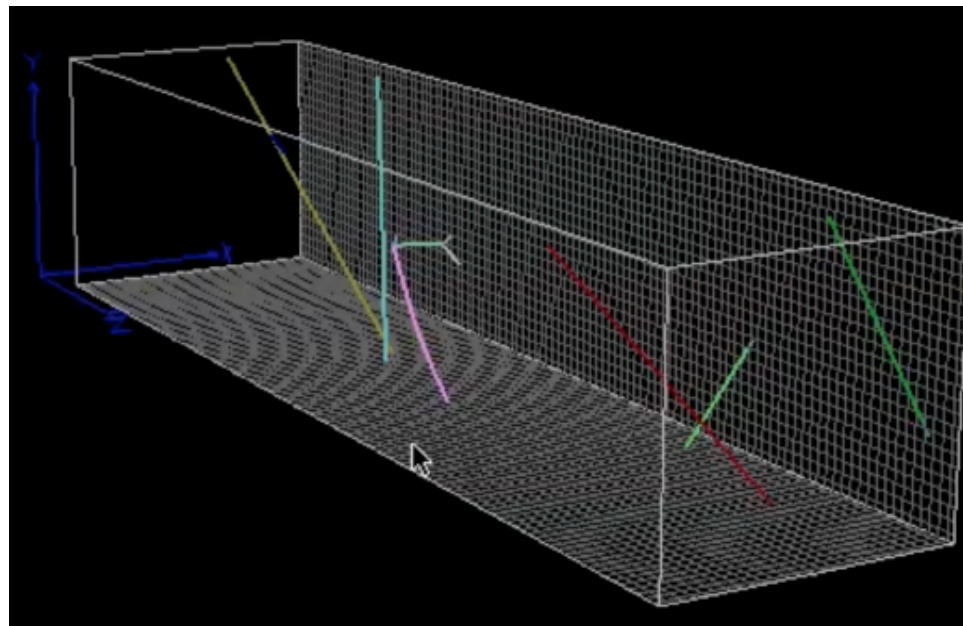

4. Challenge of LArTPC technology

Positive ion problem

- Cosmic rays of MicroBooNE is $\sim 10\text{kHz}$
- They produce tons of argon ions
- Speed of argon ions ($\sim \text{cm/s}$) $<$ liquid argon flows
- Vortex of liquid argon flow behave like a “sink” of positive ions
- Electric field inside of the TPC is never straight

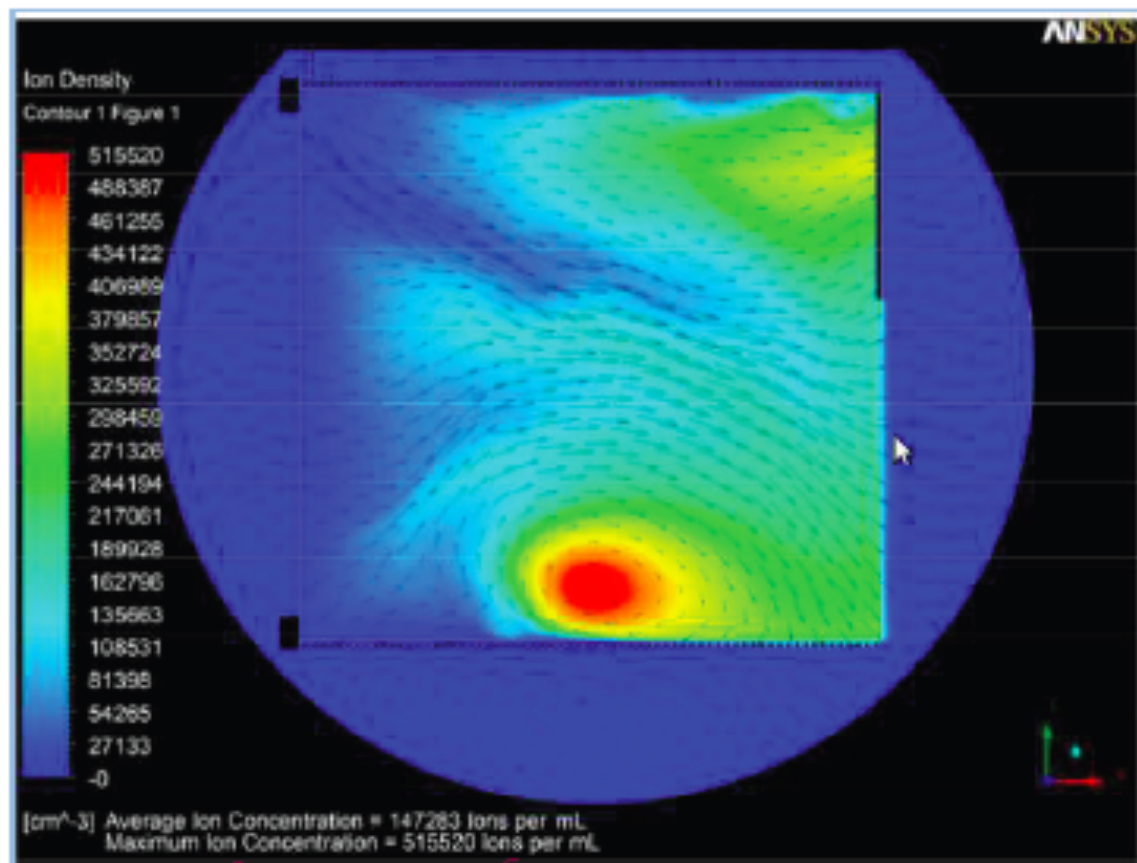

4. Challenge of LArTPC technology

Positive ion problem

- Cosmic rays of MicroBooNE is $\sim 10\text{kHz}$
- They produce tons of argon ions
- Speed of argon ions ($\sim \text{cm/s}$) $<$ liquid argon flows
- Vortex of liquid argon flow behave like a “sink” of positive ions
- Electric field inside of the TPC is never straight

Con – ICARUS surface running

- ICARUS took cosmic ray data on surface, and it shows perfect parallel lines of comic rays, showing electric field is uniform across the detector
- ICARUS and MicroBooNE has different cryostat, cooling, flow system, etc

To manage field distortion, MicroBooNE has a laser calibration system.

We will find out this effect from MicroBooNE data

How about LBNE? (also surface running)

4. Challenge of LArTPC technology

High voltage system

- MicroBooNE need to drift 2.5m
- Drift velocity is chosen to be same with ICARUS (1.5m/ms)
- It requires 500V/cm \rightarrow 125kV total
- It sounds easy if we trust what textbook said...

Table 3.3 Maximum breakdown strengths of some liquids

Liquid	Maximum breakdown strength (MV/cm)
Hexane	1.1–1.3
Benzene	1.1
Transformer oil	1.0
Silicone	1.0–1.2
Liquid Oxygen	2.4
Liquid Nitrogen	1.6–1.9
Liquid Hydrogen	1.0
Liquid Helium	0.7
Liquid Argon	1.10–1.42

4. Challenge of LArTPC technology

High voltage system

- MicroBooNE need to drift 2.5m
- Drift velocity is chosen to be same with ICARUS (1.5m/ms)
- It requires 500V/cm → 125kV total
- It sounds easy if we trust what textbook said...

Swan and Lewis, Proc.Phys.Soc.78(1961)448

The Influence of Cathode and Anode Surfaces on the Electric Strength of Liquid Argon

Original paper

- Real break-down mechanism in liquid argon is very complicated (material, surface structure, etc), no such simple number is quoted in the original paper...

BY D. W. SWAN AND T. J. LEWIS

Electrical Engineering Department, Queen Mary College,
Mile End Road, London, E.1

MS. received 13th March 1961

Abstract. The electric strength of liquefied argon is found to depend to a marked degree on the nature of both cathode and anode. This effect has been investigated systematically. The cathode is thought to influence the strength through the

Table 1. Electric Strength of Liquid Argon with Anode and Cathode of Different Materials

Cathode material	Anode material	Electric strength (mv cm ⁻¹)
Aluminium (15)	Aluminium (15)	0.69
Aluminium (15)	Stainless steel (15)	1.44
Stainless steel (15)	Aluminium (15)	0.88
Stainless steel (15)	Stainless steel (15)	1.86
Stainless steel (0)	Gold	1.22
Stainless steel (17)	Gold	1.26

The period of oxidation in minutes is indicated in brackets.

liquid, whilst the anode becomes important if the cathode exceeds that at which the anode space charge field is set up near the anode necessary for breakdown. By measuring the maintaining various concentrations of oxygen, the anode space charge is formed only when it is carried by negative oxygen ions. The strength is sensitive to small concentrations of oxygen.

4. Challenge of LArTPC technology

High voltage system

- MicroBooNE need to drift 2.5m
- Drift velocity is chosen to be same with ICARUS (1.5m/ms)
- It requires 500V/cm → 125kV total
- It sounds easy if we trust what textbook said...

MicroBooNE prototype feed-through has a hard time to send 125kV, if this doesn't work, MicroBooNE need to run with lower voltage than designed (500V/cm → ?)

- longer drift time (larger DAQ window)
- more cosmic rays in beam window
- more positive ion effect
- more diffusions (worse resolution)
- more recombination (less ionization signal)

Hope is future experiments figure out better HV-system

4. Challenge of LArTPC technology

Reconstruction

- Event topology is extremely richer than any existing detectors
- Reconstruction is not easy, sensitivity study is based on MC truth or MC truth with detector effect (called fast MC), to avoid reconstruction
- Otherwise, efficiency is estimated from hand scan

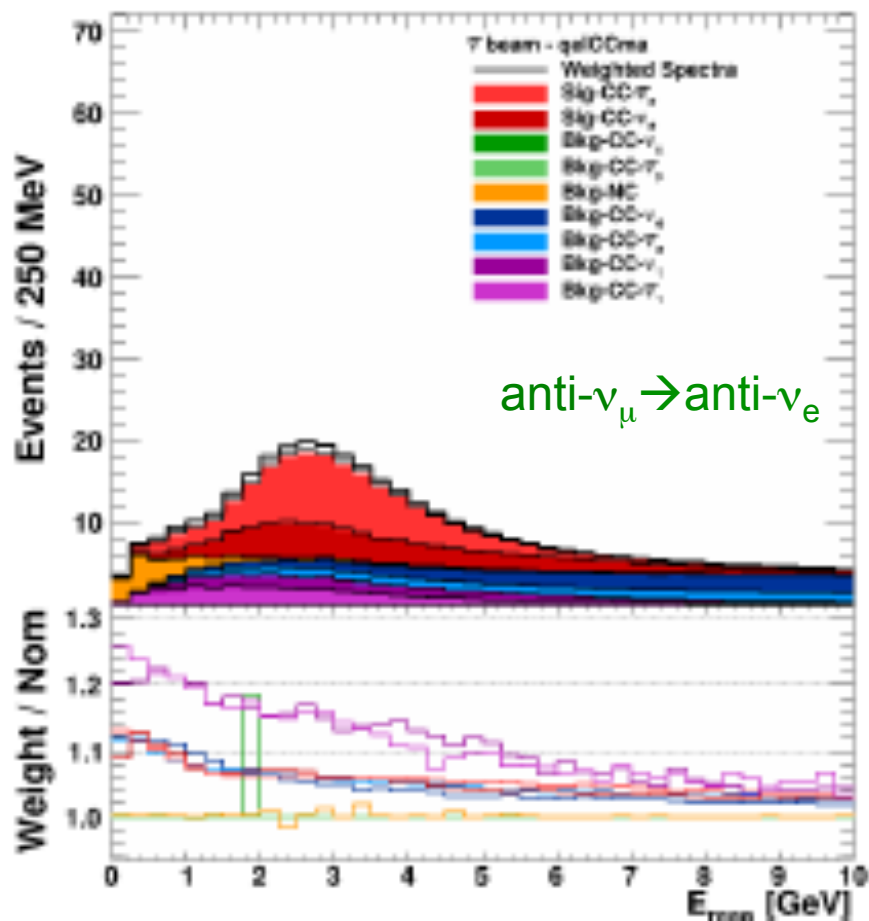
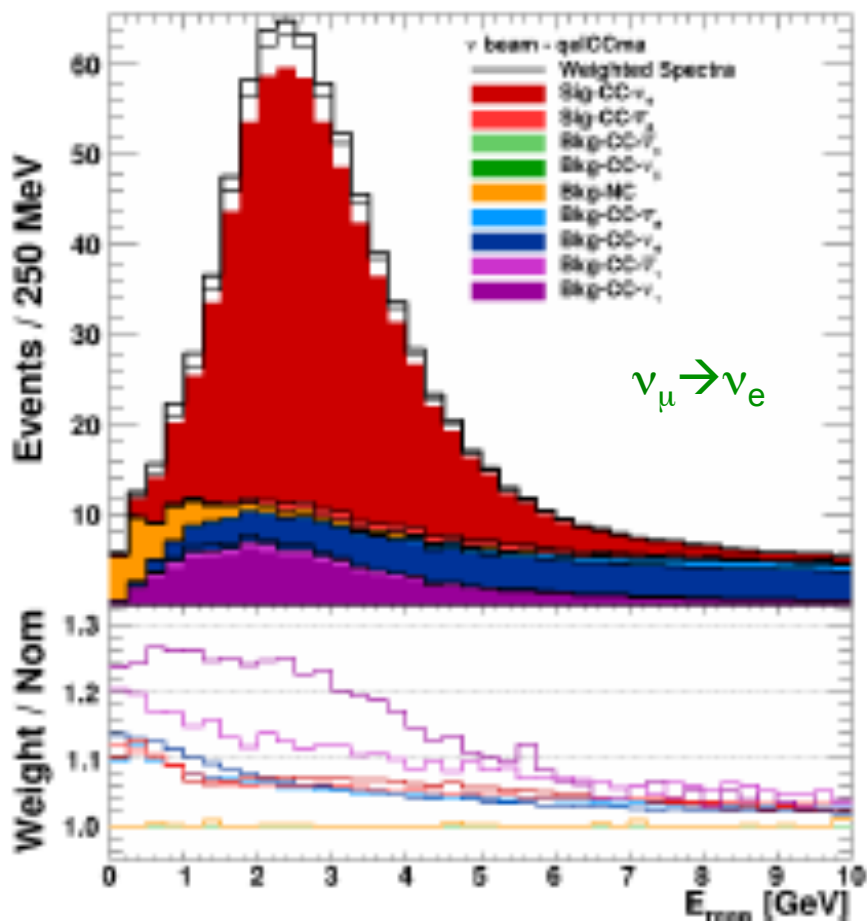

4. Challenge of LArTPC technology

No nuclear model

- In this energy region (<few GeV), nuclear effect is important (cf Kevin McFarland's talk).
- Argon nucleus is too big to calculate precisely. The best ab initio nuclear model is available only up to ^{12}C .
- Nuclear model is up to phenomenological one.

MicroBooNE should be able to test these phenomenological models, to reduce errors for future experiments.

Not many physics

- There are so many new LArTPC experiments without any physics motivations.
- If LBNE is built on surface, there is no underground science (no proton decay, no supernova neutrinos).
- Even it were underground, Hyper-Kamiokande would have better results for any of these physics...

Conclusion

LArTPC technology is initiated by ICARUS, and now flourish in US

There are number of projects actively studying LArTPC

MicroBooNE is up coming neutrino beam experiment with LArTPC

All effort focus to the future large LArTPC, such as LBNE

Thank you for your attention!